



NX350h

Gasoline-Electric

Lexus Hybrid Drive

HYBRID VEHICLE DISMANTLING MANUAL

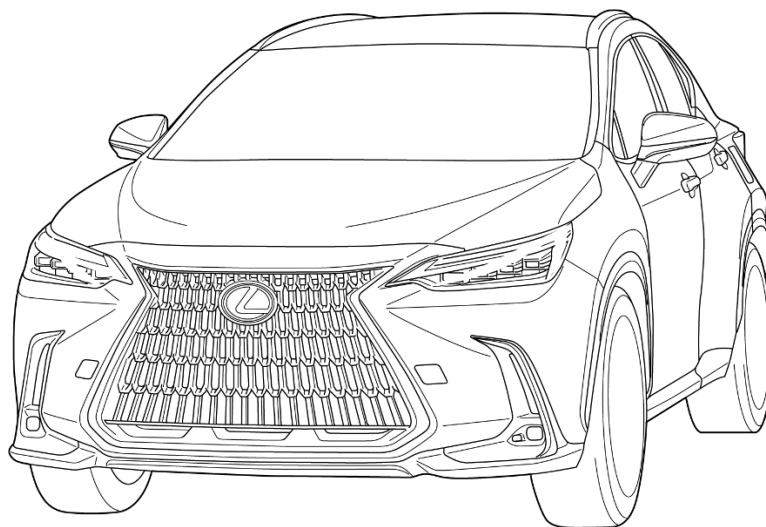

AAZH20/AAZH25 Series

Foreword

This guide was developed to educate and assist dismantlers in the safe handling of Lexus NX350h gasoline-electric hybrid vehicles. NX350h dismantling procedures are similar to other non-hybrid Lexus vehicles with the exception of the high voltage electrical system. It is important to recognize and understand the high voltage electrical system features and specifications of the Lexus NX350h, as they may not be familiar to dismantlers.

High voltage electricity powers the A/C compressor, electric motor, generator, and inverter/converter. All other conventional automotive electrical devices such as the head lights, radio, and gauges are powered from a separate 12 V auxiliary battery. Numerous safeguards have been designed into the NX350h to help ensure the high voltage, approximately 259 V, Lithium-ion (Li-ion) Hybrid Vehicle (HV) battery assembly is kept safe and secure in an accident.

The Li-ion HV battery assembly contains sealed batteries that are similar to rechargeable batteries used in some battery operated power tools and other consumer products. The electrolyte is absorbed in the cell plates and will not normally leak out even if the battery is cracked. In the unlikely event the electrolyte does leak, it can be easily neutralized with a dilute boric acid solution or vinegar.

High voltage cables, identifiable by orange insulation and connectors, are isolated from the metal chassis of the vehicle.

Additional topics contained in the guide include:

- Lexus NX350h identification.
- Major hybrid component locations and descriptions.

By following the information in this guide, dismantlers will be able to handle NX350h hybrid-electric vehicles as safely as the dismantling of a conventional gasoline engine automobile.

© 2021 Toyota Motor Corporation

All rights reserved. This book may not be reproduced or copied, in whole or in part, without the written permission of Toyota Motor Corporation.

Table of Contents

| | |
|--|------------------|
| <u>About the NX350h</u> | <u>1</u> |
| <u>NX350h Identification</u> | <u>2</u> |
| Exterior | <u>3</u> |
| Interior..... | <u>4</u> |
| Engine Compartment..... | <u>5</u> |
| <u>Hybrid Component Locations & Descriptions</u> | <u>6</u> |
| Specifications..... | <u>8</u> |
| <u>Lexus Hybrid Drive Operation</u> | <u>10</u> |
| Vehicle Operation..... | <u>10</u> |
| <u>Hybrid Vehicle (HV) Battery Assembly and Auxiliary Battery</u> | <u>11</u> |
| HV Battery Assembly | <u>11</u> |
| Components Powered by the HV Battery Assembly | <u>11</u> |
| HV Battery Assembly Recycling..... | <u>12</u> |
| Auxiliary Battery | <u>12</u> |
| <u>High Voltage Safety</u> | <u>13</u> |
| High Voltage Safety System | <u>13</u> |
| Service Plug Grip | <u>14</u> |
| <u>Precaution to be observed when dismantling the vehicle</u> | <u>16</u> |
| Necessary Items | <u>16</u> |
| <u>Spills</u> | <u>17</u> |
| <u>Dismantling the vehicle</u> | <u>18</u> |
| <u>Removal of HV battery</u> | <u>24</u> |

About the NX350h

The NX350h 5-door wagon joins the hybrid model for Lexus. Lexus Hybrid Drive means that the vehicle contains a gasoline engine, a front electric motor and a rear electric motor* for power. The two hybrid power sources are stored on board the vehicle:

1. Gasoline stored in the fuel tank for the gasoline engine.
2. Electricity stored in a high voltage Hybrid Vehicle (HV) battery assembly for the front electric motor and rear electric motor*.

The result of combining these two power sources is improved fuel economy and reduced emissions. The gasoline engine also powers an electric generator to recharge the battery assembly; unlike a pure all electric vehicle, the NX350h never needs to be recharged from an external electric power source.

Depending on the driving conditions one or both sources are used to power the vehicle. The following illustration demonstrates how the NX350h operates in various driving modes.

- ❶ During light acceleration at low speeds, the vehicle is powered by the front electric motor and rear electric motor*. The gasoline engine is shut off.
- ❷ During normal driving, the vehicle is powered mainly by the gasoline engine. The gasoline engine also powers the generator to recharge the battery assembly and to drive the motor.
- ❸ During full acceleration, such as climbing a hill, both the gasoline engine, the front electric motor and rear electric motor* power the vehicle.
- ❹ During deceleration, such as when braking, the vehicle regenerates kinetic energy from the front wheels to produce electricity that recharges the battery assembly.
- ❺ While the vehicle is stopped, the gasoline engine, front electric motor and rear electric motor* are off, however the vehicle remains on and operational.

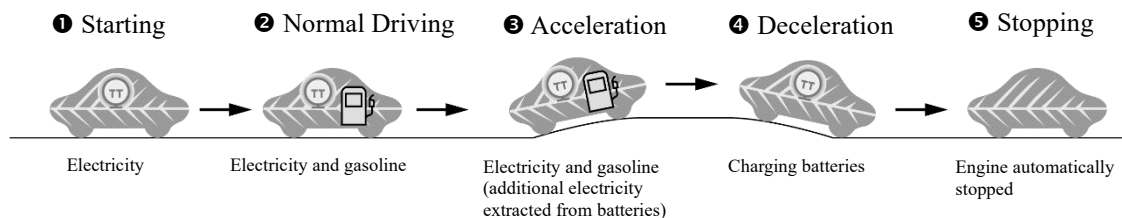

*: for AWD

NX350h Identification

In appearance, NX350h is nearly identical to the conventional, non-hybrid Lexus NX350. The NX350h is a 5-door wagon. Exterior, interior, and engine compartment illustrations are provided to assist in identification.

The alphanumeric 15 character Vehicle Identification Number (VIN) is provided on the left side windshield cowl, floor under the right side front seat and left side B pillar.

Example VIN:



A NX350h is identified by the 5th alphanumeric character of the VIN.

| ① | Drive Type | Engine Series | Destination |
|---|------------|---------------|--------------|
| C | 2WD | A25A-FXS | except CHINA |
| K | AWD | A25A-FXS | except CHINA |
| M | 2WD | A25B-FXS | except CHINA |
| B | 2WD | A25B-FXS | CHINA |
| L | AWD | A25B-FXS | except CHINA |
| H | AWD | A25B-FXS | CHINA |

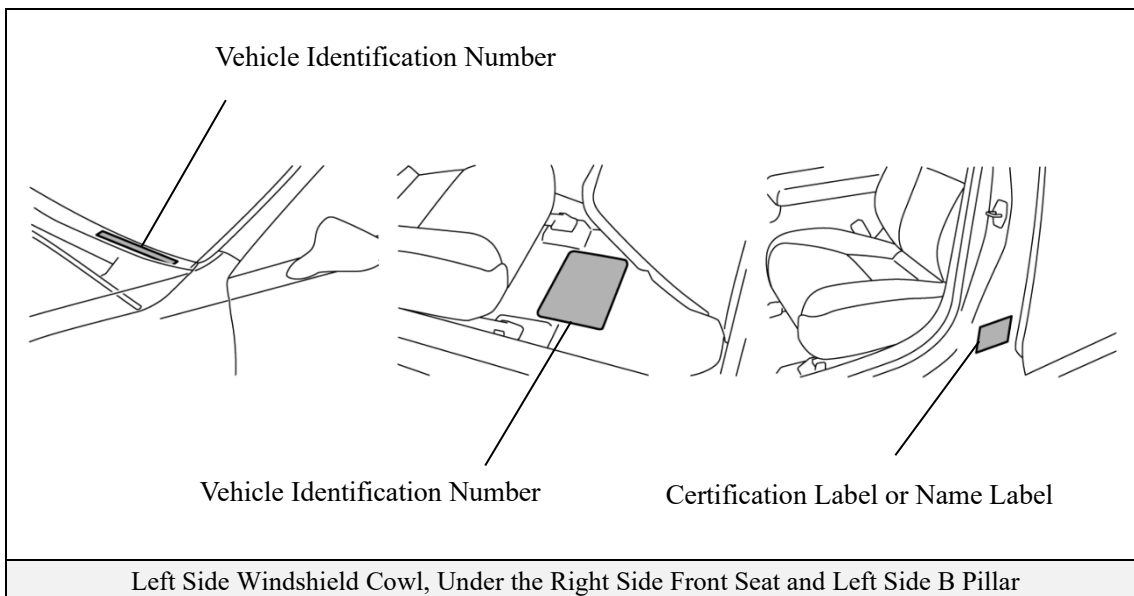

Exterior

- ❶ NX350h logos on the back door.
- ❷ Gasoline fuel filler door located on left side rear quarter panel.

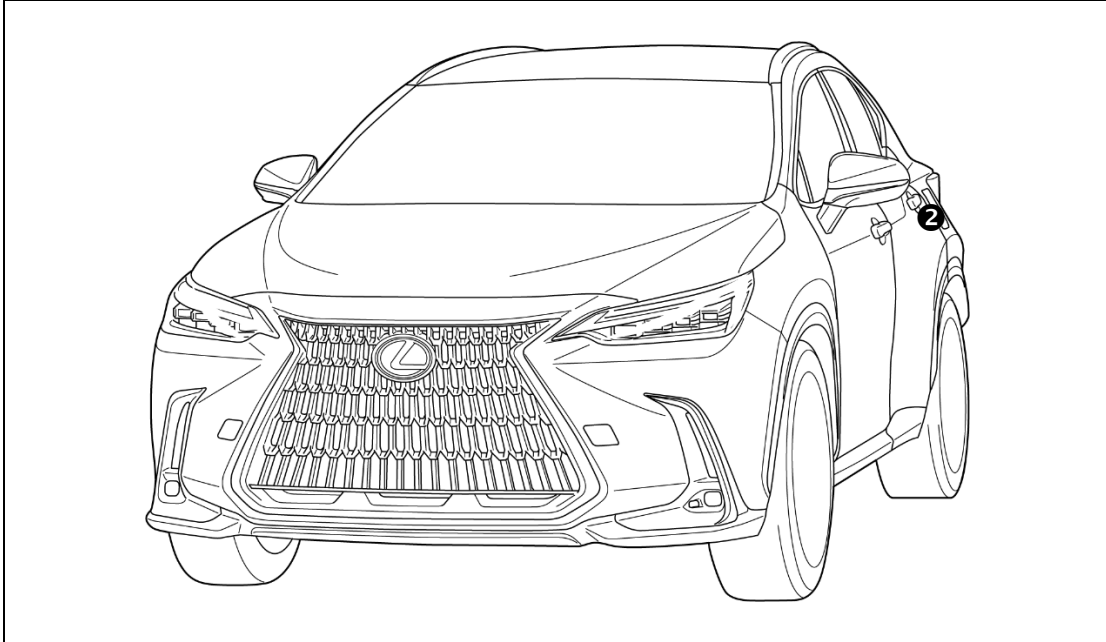

Exterior Front and Left Side View

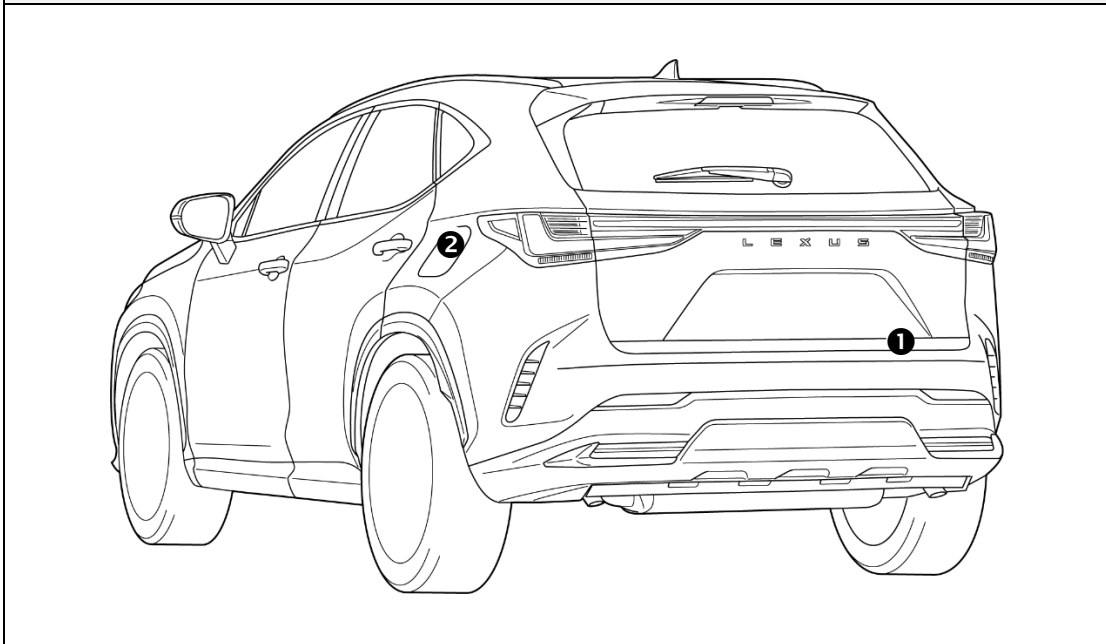

Exterior Rear and Left Side View

Interior

- ③ The instrument cluster (hybrid system indicator, **READY** indicator and warning lights) located in the dash behind the steering wheel, is different than the one on the conventional, non-hybrid NX350.
- ④ In Place of a tachometer, a hybrid system indicator is used to show power output.

NOTICE:

If the vehicle is shut off, the instrument cluster gauges will be “blacked out”, not illuminated.

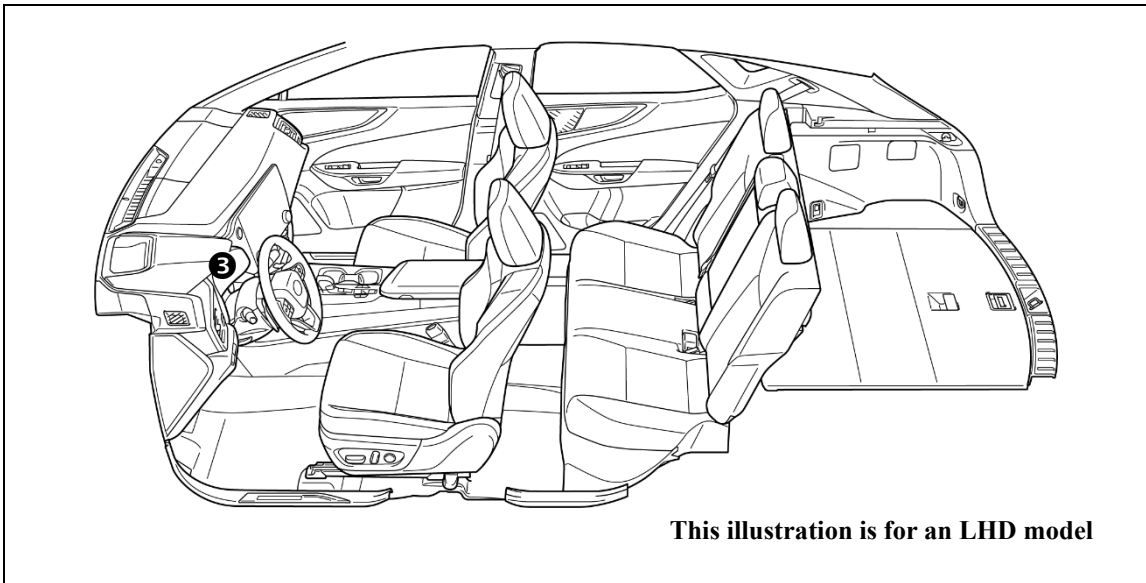

Interior View

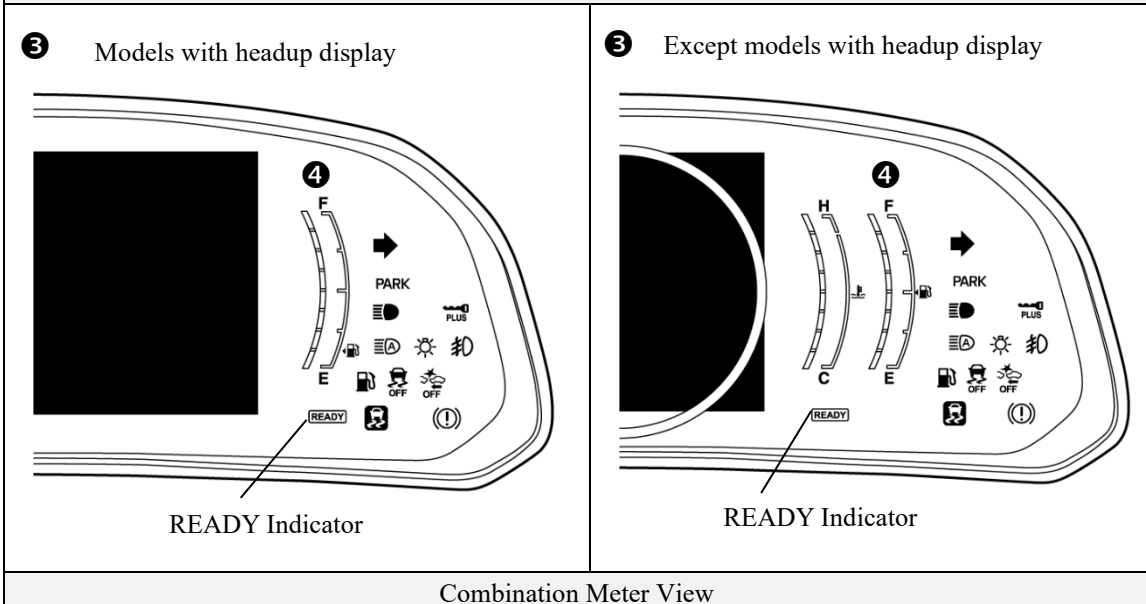

Engine Compartment

- ⑤ 2.5-liter aluminum alloy gasoline engine.
- ⑥ Orange colored high voltage power cables.

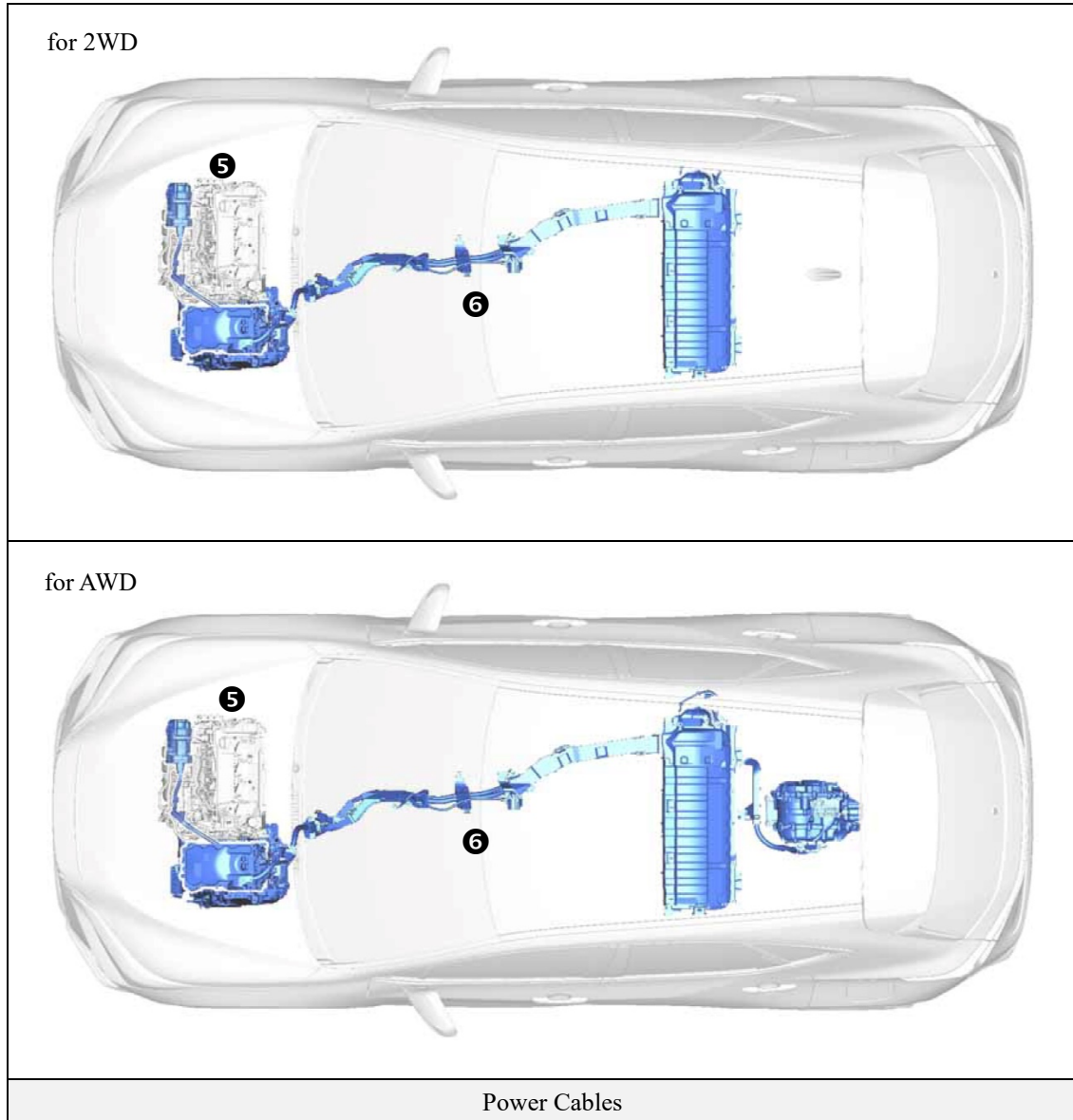

Hybrid Component Locations & Descriptions

| Component | Location | Description |
|--|--------------------------------------|--|
| 12 Volts Auxiliary Battery ❶ | Luggage Compartment Area | Supplies electricity to the electrical components. |
| Hybrid Vehicle (HV) Battery Assembly ❷ | Cabin Area, Mounted Under Rear Seat | <ul style="list-style-type: none"> •Supplies electrical power to MG1, MG2 and MGR*1 in accordance with the driving conditions of the vehicle. •Recharged by MG1, MG2 and MGR*1 in accordance with the SOC and the driving conditions of the vehicle. |
| Power Cables ❸ | Undercarriage and Engine Compartment | Connects the HV battery, inverter with converter assembly, hybrid vehicle transaxle assembly, rear drive unit (rear traction motor with transaxle assembly)*1 and compressor with motor assembly. |
| Inverter/Converter ❹ | Engine Compartment | <ul style="list-style-type: none"> •Converts the direct current from the boost converter into alternating current for MG1, MG2 and MGR*1, and vice versa (from AC to DC). •Boosts the HV battery nominal voltage of DC 259 Volts up to a maximum voltage of DC 650 Volts and vice versa (steps down DC 650 Volts to DC 259 Volts). |
| Gasoline Engine ❺ | Engine compartment | <p>Provides two functions:</p> <ol style="list-style-type: none"> 1) Powers vehicle. 2) Powers generator to recharge the HV battery assembly. <p>The engine is started and stopped under control of the vehicle computer.</p> |
| Front Electric Motor ❻ | Engine compartment | <ul style="list-style-type: none"> •MG2, which is driven by electrical power from MG1 and the HV battery, generates motive force for the drive wheels. •During braking, or when the accelerator pedal is not depressed, it generates high-voltage electricity to recharge the HV battery. |

| Component | Location | Description |
|--|-------------------------------|---|
| Electric Generator ⑦ | Engine compartment | MG1, which is driven by the engine, generates high-voltage electricity in order to operate MG2, MGR*1 and charge the HV battery. Also, it functions as a starter to start the engine. |
| A/C Compressor (with inverter) ⑧ | Engine compartment | 3-phase high voltage AC electrically driven motor compressor. |
| DC-DC Converter for 12 Volts Auxiliary Battery ⑨ | Engine compartment | Steps down the HV battery nominal voltage of DC 259 Volts to approximately DC 14 Volts in order to supply electricity to the electrical components, as well as to recharge the auxiliary battery. |
| Fuel Tank and Fuel Line ⑩ | Undercarriage and Center | The fuel tank provides gasoline via a fuel line to the engine. The fuel line is routed under the center of vehicle. |
| Rear Electric Motor ⑪ *1 | Under the Luggage Compartment | MGR, which is driven by electrical power from MG1 and the HV battery, generates motive force for the drive wheels. |

*Numbers in the component column apply to the illustrations on the following page.

*1: for AWD

Specifications

- Gasoline Engine: 131 kW, 2.5-liter Aluminum Alloy Engine
- Electric Motors
- Front: 134 kW, Permanent Magnet Motor
 - Rear: 40 kW, Permanent Magnet Motor (for AWD)
- Transmission: Automatic Only
- HV Battery: 259 V Sealed Li-ion-Battery
- Curb Weight: 3,814-3,990 lbs / 1,730-1,810 kg
3,946-4,123 lbs / 1,790-1,870 kg (for AWD)
- Fuel Tank: 12.1 Imp gals / 14.5 U.S. gals / 55 liters
- Frame Material: Steel Unibody
- Body Material: Steel Panels
- Seating Capacity: 5 passenger

for 2WD

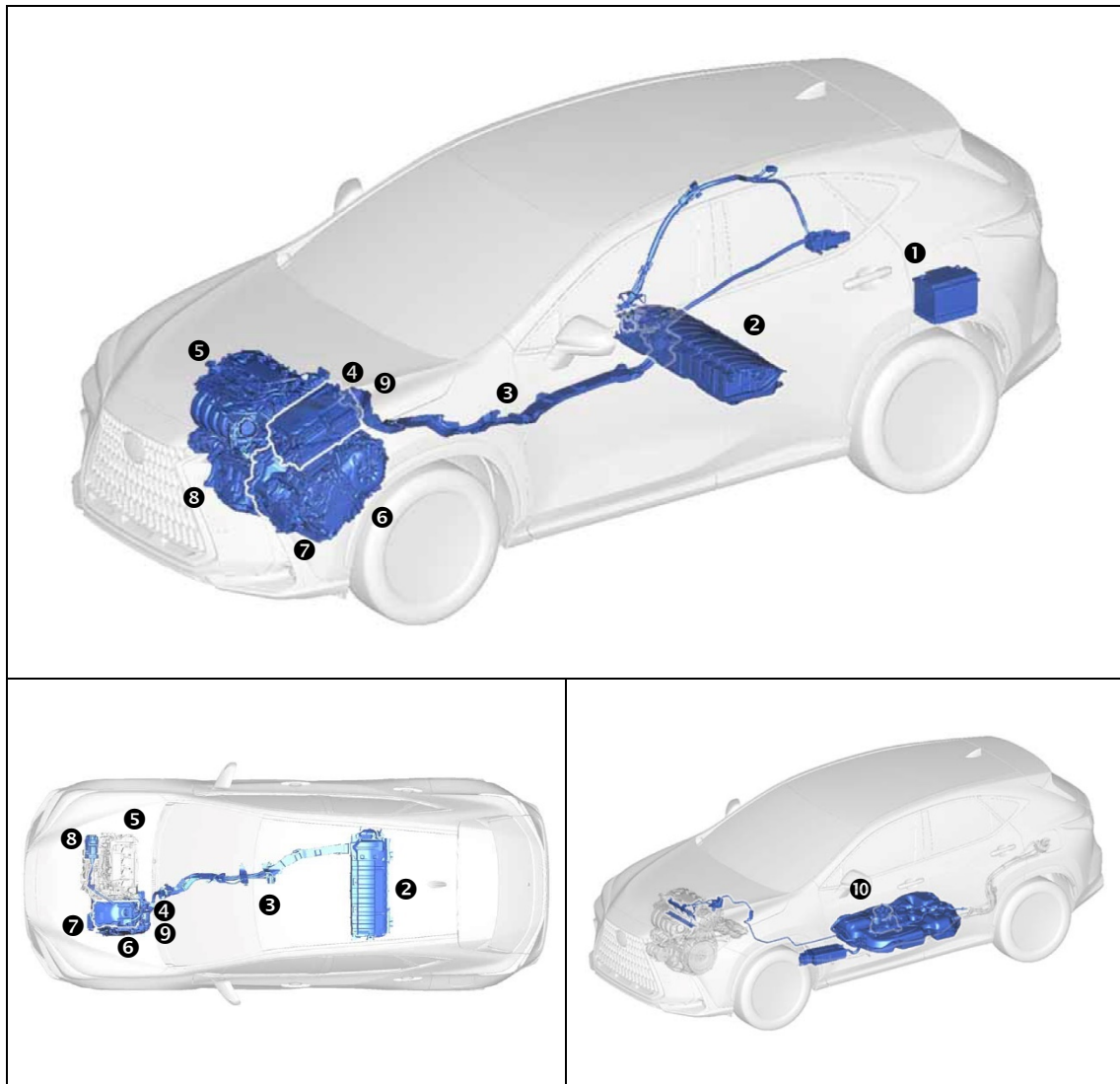

for AWD

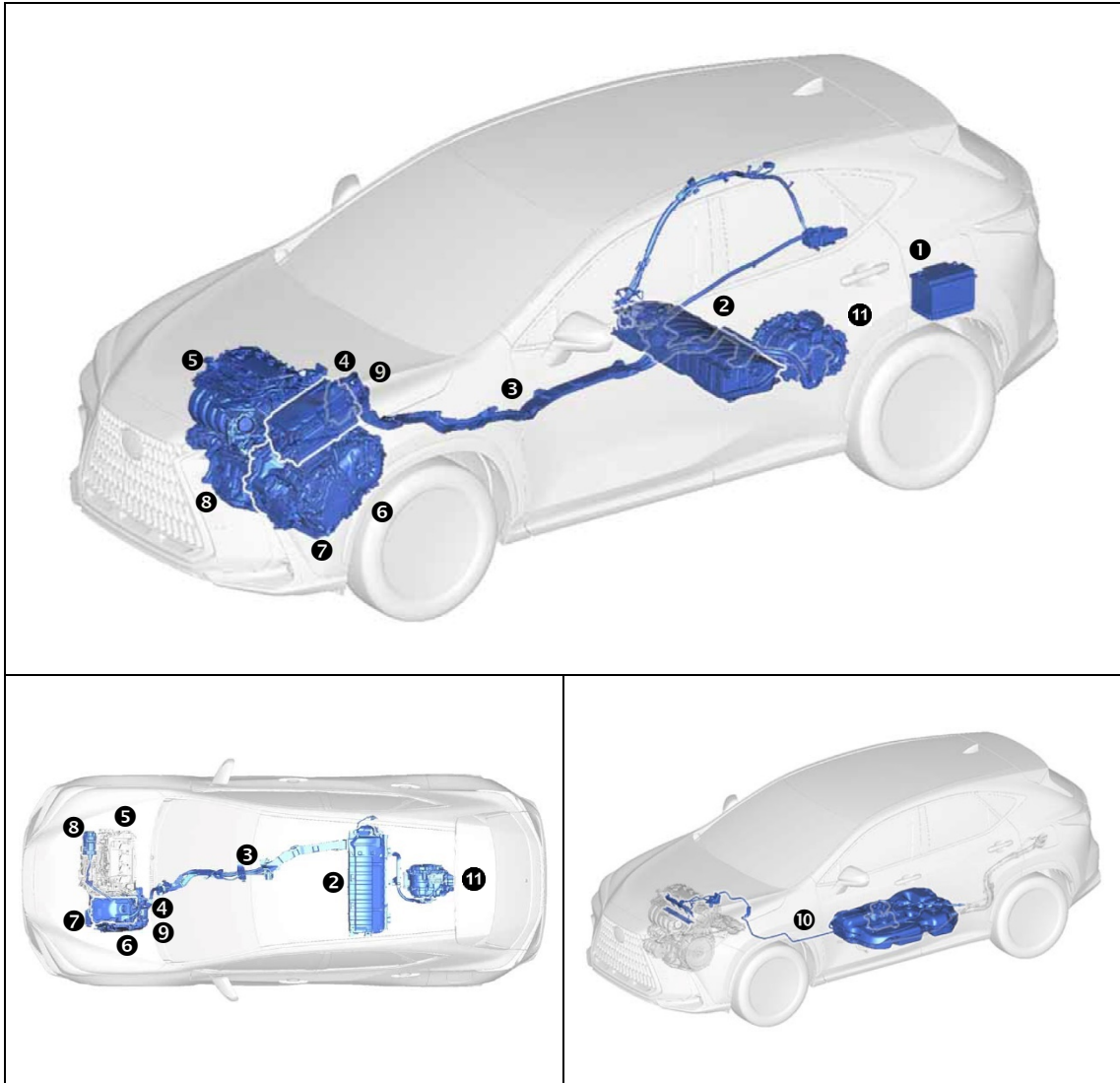

Lexus Hybrid Drive Operation

Once the **READY** indicator is illuminated in the instrument cluster, the vehicle may be driven. However, the gasoline engine does not idle like a typical automobile and will start and stop automatically. It is important to recognize and understand the **READY** indicator provided in the instrument cluster. When illuminated, it informs the driver that the vehicle is on and operational even though the gasoline engine may be off and the engine compartment is silent.

Vehicle Operation

- With the NX350h, the gasoline engine may stop and start at any time while the **READY** indicator is on.
- Never assume that the vehicle is shut off just because the engine is off. Always look for the **READY** indicator status. The vehicle is shut off when the **READY** indicator is off.

The vehicle may be powered by:

1. The electric motor only.
2. A combination of both the electric motor and the gasoline engine.

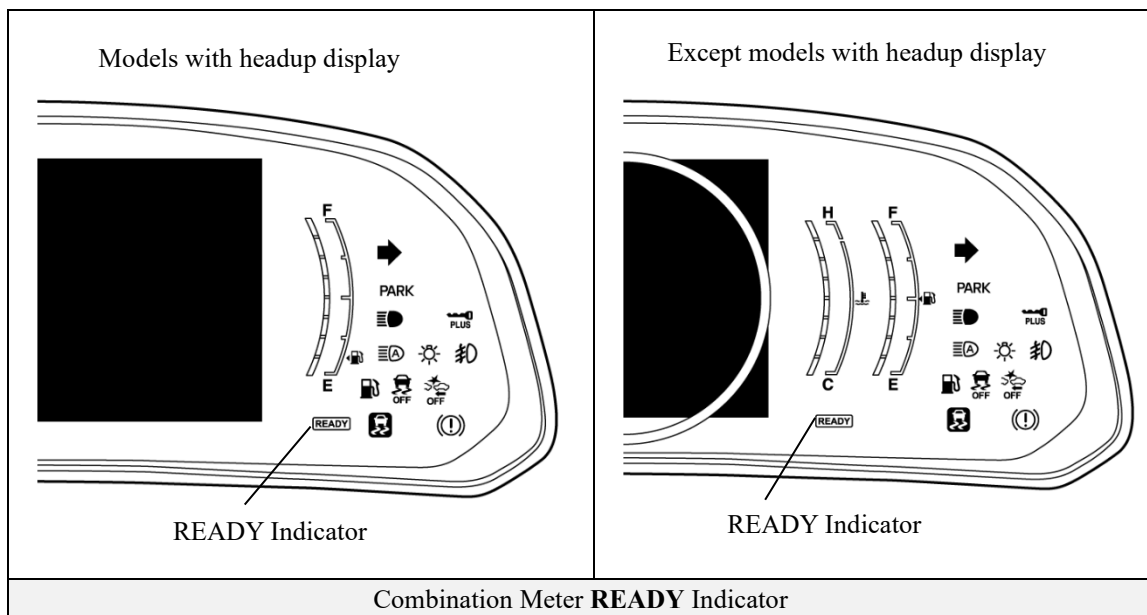

Hybrid Vehicle (HV) Battery Assembly and Auxiliary Battery

The NX350h features a high voltage Hybrid Vehicle (HV) battery assembly that contains sealed Lithium-ion (Li-ion) battery cells.

HV Battery Assembly

- The HV battery assembly is enclosed in a metal case and is rigidly mounted to the cabin area under the rear seat. The metal case is isolated from high voltage and concealed by carpet covers in the cabin area.
- The HV battery assembly consists of 70 low voltage (3.7 Volt) Li-ion battery cells connected in series to produce approximately 259 Volts. Each Li-ion battery cell is non-spillable and in a sealed case.
- The electrolyte used in the Li-ion battery cells is a flammable organic electrolyte. The electrolyte is absorbed into the battery cell separator and will not normally leak, even in a collision.

| HV Battery Assembly | |
|--|-----------|
| Battery assembly voltage | 259 Volts |
| Number of Li-ion battery cells in the pack | 70 |
| Li-ion battery cell voltage | 3.7 Volts |

Components Powered by the HV Battery Assembly

- Electric Motor
- Power Cables
- A/C Compressor
- Electric Generator
- Inverter/Converter
 - DC-DC Converter for 12 Volts Auxiliary Battery

HV Battery Assembly Recycling

- The HV battery assembly is recyclable. Contact either your Lexus Distributor or the nearest Lexus dealer.

Auxiliary Battery

- The NX350h also contains a sealed lead-acid 12 Volts battery. This 12 Volts auxiliary battery powers the vehicle electrical system similar to a conventional vehicle. As with other conventional vehicles, the auxiliary battery is grounded to the metal chassis of the vehicle.
- The auxiliary battery is located under the luggage compartment area. It is concealed by a plastic resin cover on the left side in the battery compartment.

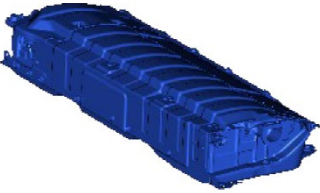
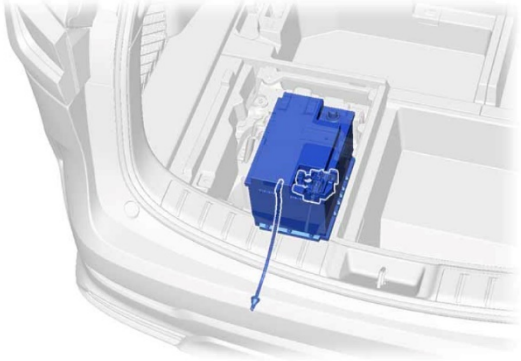
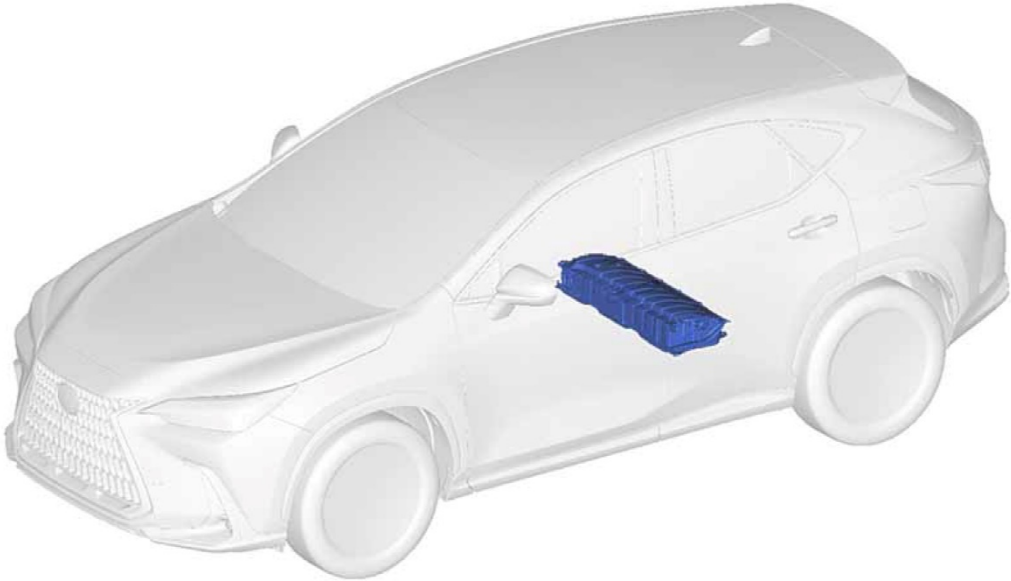
| | |
|--|---|
|  |  |
| 259 Volts HV Battery Assembly | 12 Volts Auxiliary Battery Mounted in Luggage Compartment Area (Left Side) |
|  | |
| HV Battery Assembly Mounted in Cabin Area | |

High Voltage Safety

The HV battery assembly powers the high voltage electrical system with DC electricity. Positive and negative orange colored high voltage power cables are routed from the battery assembly, under the vehicle floor pan, to the inverter/converter. The inverter/converter contains a circuit that boosts the HV battery voltage from 259 to 650 Volts DC. The inverter/converter creates 3-phase AC to power the motor. Power cables are routed from the inverter/converter to each high voltage motor (front and rear electric motor, electric generator, and A/C compressor). The following systems are intended to help keep occupants in the vehicle and emergency responders safe from high voltage electricity:

High Voltage Safety System

- A high voltage fuse ❶* provides short circuit protection in the HV battery assembly.
- Positive and negative high voltage power cables ❷* connected to the HV battery assembly are controlled by 12 Volts normally open relays ❸*. When the vehicle is shut off, the relays stop electricity flow from leaving the HV battery assembly.



WARNING:

- ***The high voltage system may remain powered for up to 10 minutes after the vehicle is shut off or disabled. To prevent serious injury or death from severe burns or electric shock, avoid touching, cutting, or opening any orange high voltage power cable or high voltage component.***

- Both positive and negative power cables ❹* are insulated from the metal body. High voltage electricity flows through these cables and not through the metal vehicle body. The metal vehicle body is safe to touch because it is insulated from the high voltage components.
- A ground fault monitor ❺* continuously monitors for high voltage leakage to the metal chassis while the vehicle is running. If a malfunction is detected, the hybrid vehicle computer ❻* will illuminate the master warning light  in the instrument cluster and a message indicating that the hybrid system is malfunctioning will be displayed on the multi-information display.
- The HV battery assembly relays will automatically open to stop electricity flow in a collision sufficient to activate the SRS.

*Numbers apply to the illustration on the following page.

Service Plug Grip

- The high voltage circuit is cut by removing the service plug grip (see page 18).

for 2WD

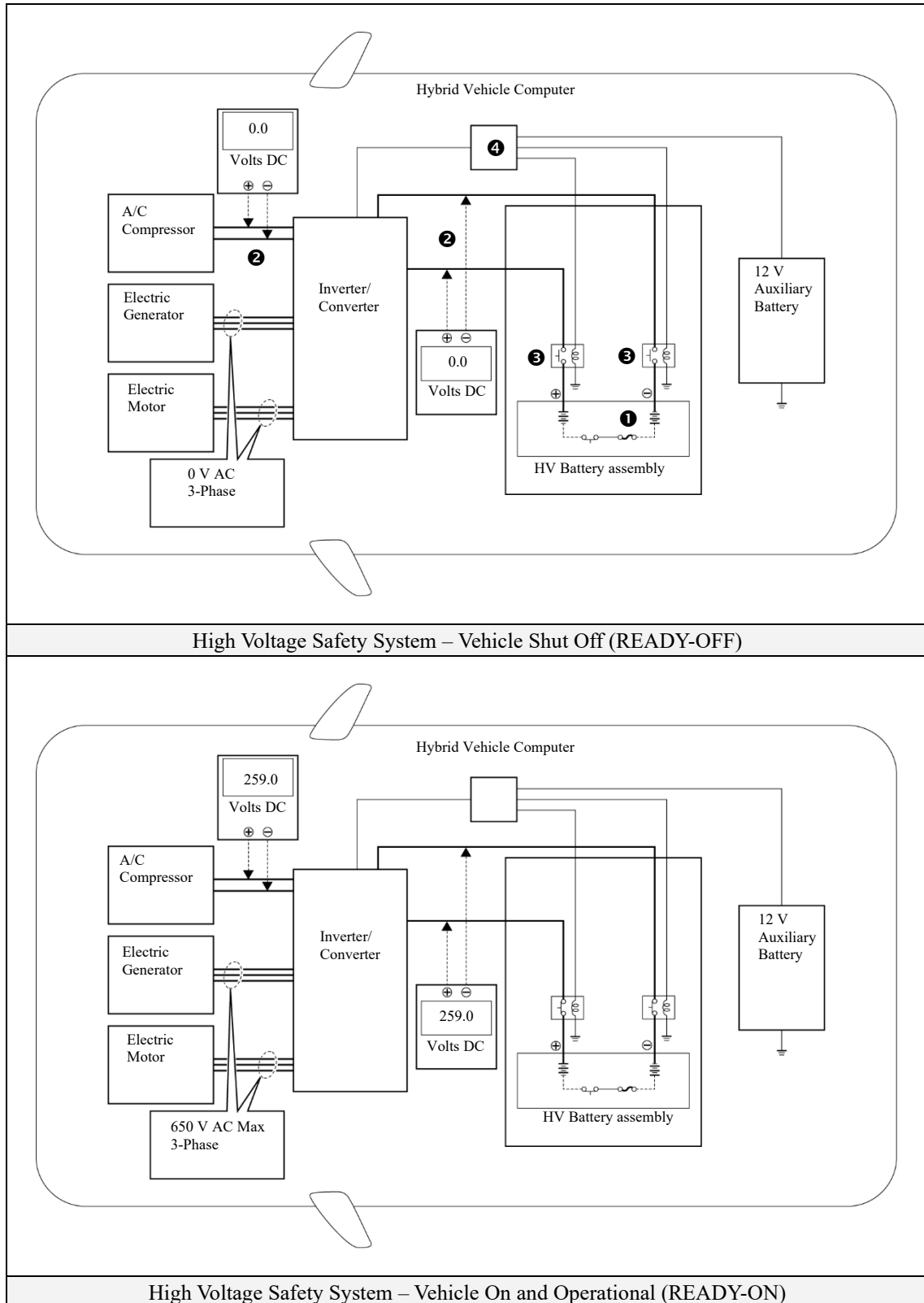

for AWD

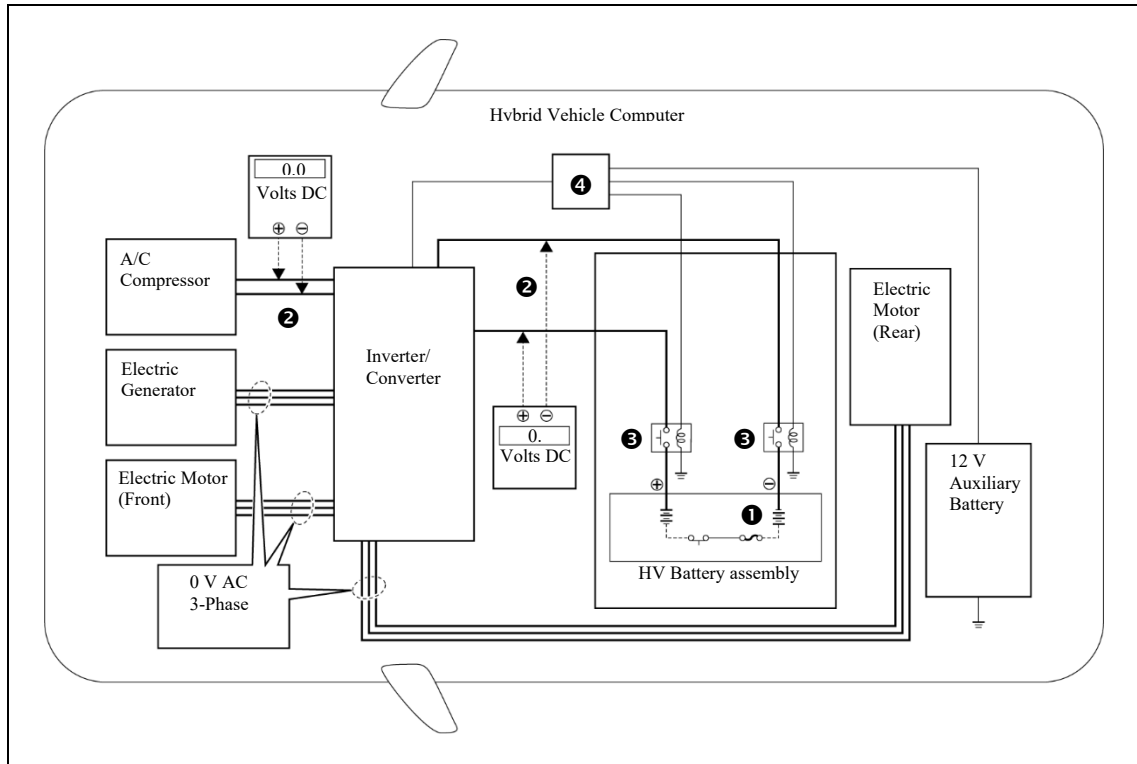

High Voltage Safety System – Vehicle Shut Off (READY-OFF)

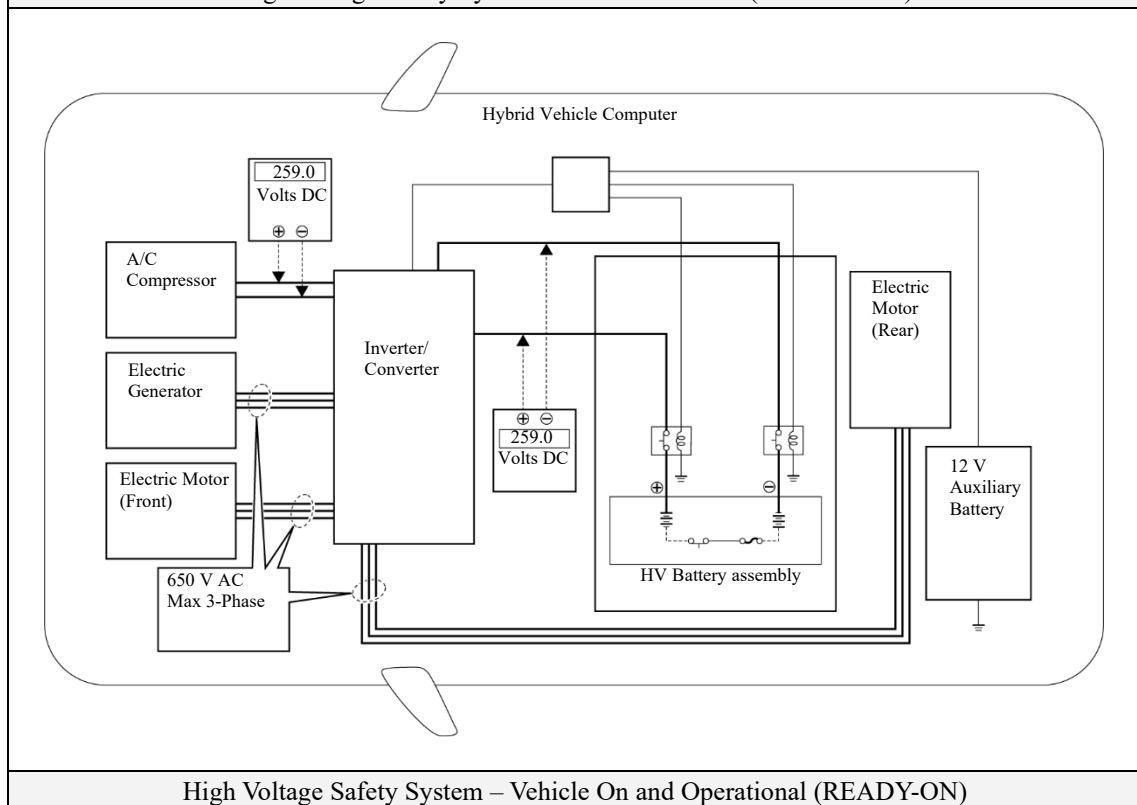

High Voltage Safety System – Vehicle On and Operational (READY-ON)

Precaution to be observed when dismantling the vehicle

- To prevent electric shock, wear insulated gloves when working on wire harnesses and components of the high voltage system.
Before using insulated gloves, be sure to check them for cracks, tears and other types of damage.
- When servicing the vehicle, do not carry metal objects like mechanical pencils or rulers that can be dropped accidentally and cause a short circuit.
- To reduce the risk of electric shock, make sure to remove the service plug grip to cut off the high voltage circuit before servicing the vehicle.
- To reduce the risk of electric shock, make sure to wait at least 10 minutes after removing the service plug grip to fully discharge the high voltage capacitor inside the inverter with converter assembly.
- Do not touch any high voltage wire harnesses, connectors or parts with bare hands.
- Do not touch the terminals of the service plug grip.
- Make sure to insulate the high-voltage connectors and terminals of the HV battery with insulating tape after removing them.
- After removing the service plug grip, put it in your pocket to prevent other technicians from accidentally reconnecting it while you are working on the high-voltage system.
- Before touching a bare high-voltage terminal, wear insulated gloves and use a tester to make sure that the terminal voltage is 0 V.
- Electrolyte leaks may cause acute poisoning if a high concentration of the vapor from the electrolyte is inhaled. In case of inhalation, move the affected person to a place with ample fresh air and let them lie quietly. Seek medical care.
- If the electrolyte comes in contact with your skin, wash the area thoroughly with soap and plenty of water, and seek medical care. If the electrolyte comes in contact with an article of clothing, take it off immediately. Prolonged contact with the electrolyte may cause skin irritation.
- If the electrolyte comes in contact with your eyes, call out loudly for help. Do not rub your eyes. Immediately flush them with a large amount of water for at least 15 minutes and seek medical care.
- If electrolyte is swallowed, seek medical care immediately. Do not induce vomiting, unless instructed by the doctor.
- If the vehicle catches on fire, use an ABC fire extinguisher to extinguish the fire.
Trying to extinguish a fire using only a small amount of water can be more dangerous than effective. Use a substantial amount of water or wait for firefighters.
- Do not allow any foreign matter or water to enter the HV battery.

Necessary Items

- Protective clothing such as insulated gloves (electrically insulated), rubber gloves, helmet, safety goggles, safety shoes and SCBA or protective mask.
- Insulating tape such as electrical tape that has a suitable electrical insulation rating and insulation tool set.
- An electrical tester that is capable of measuring DC 750 Volts or more.

Spills

The NX350h contains the same common automotive fluids used in other non-hybrid Lexus vehicles, with the exception of the Li-ion electrolyte used in the HV battery assembly. The electrolyte used in the Li-ion battery cells is a flammable organic electrolyte. The electrolyte is absorbed into the battery cell separators, even if the battery cells are crushed or cracked, it is unlikely that liquid electrolyte will leak. Any liquid electrolyte that leaks from a Li-ion battery cell quickly evaporates.



WARNING:

- ***The Li-ion battery contains organic electrolyte. Only a small amount may leak from the batteries which may irritate the eyes, nose, throat, and skin.***
- ***Contact with the vapor produced by the electrolyte may irritate the nose and throat.***
- ***To avoid injury by coming in contact with the electrolyte or vapor, wear personal protective equipment for organic electrolyte including SCBA or protective mask for organic gases.***

- Handle Li-ion electrolyte spills using the following Personal Protective Equipment (PPE):
 - Splash shield or safety goggles. A fold down face shield is not acceptable for acid or electrolyte spills.
 - Rubber gloves or gloves suitable for organic solvents.
 - Apron suitable for organic solvents.
 - Rubber boots or boots suitable for organic solvents.
 - Protective mask for organic gases or SCBA.

Dismantling the vehicle

The following 6 pages contain general instructions for use when working on a NX350h.

Read these instructions before proceeding to the HV battery removal instructions on page 24.



WARNING:

- ***The high voltage system may remain powered for up to 10 minutes after the vehicle is shut off or disabled. To prevent serious injury or death from severe burns or electric shock, avoid touching, cutting, or opening any orange high voltage power cable or any high voltage component.***

1. Shut off the ignition (**READY** indicator is off).

2. Remove battery service cover plate.

a.

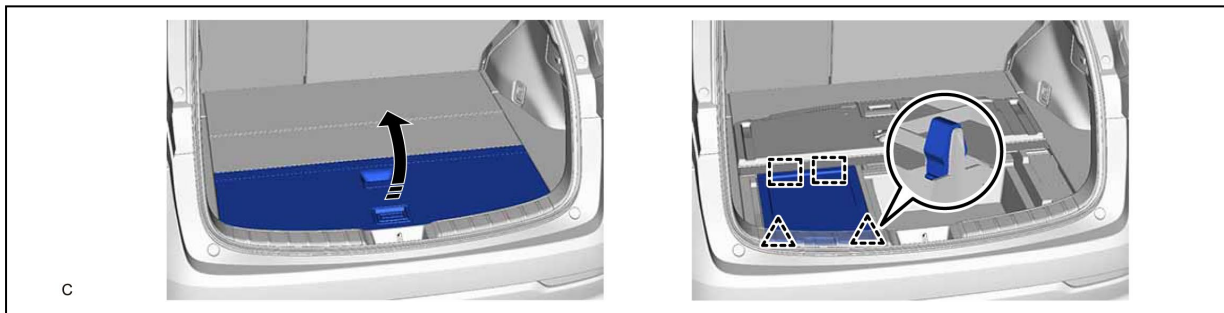

3. Disconnect cable from negative auxiliary battery terminal.

a.

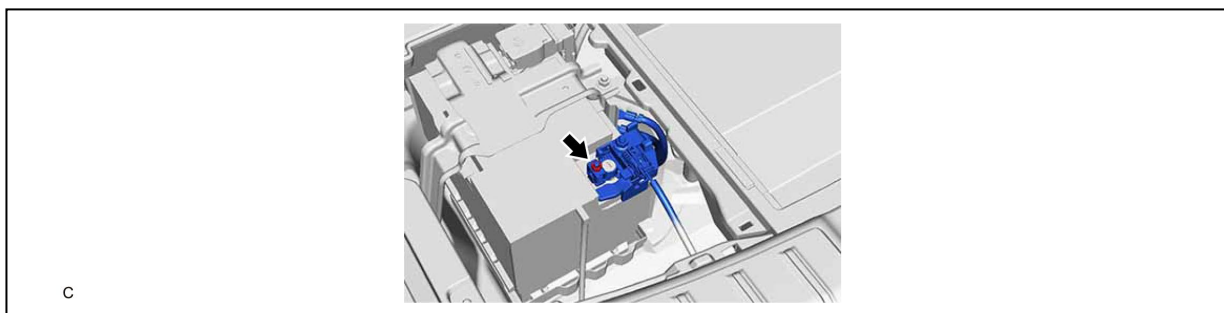

4. Remove battery service hole cover.

a.

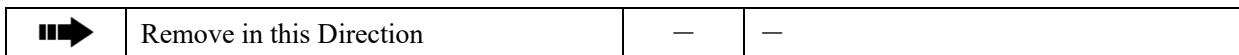
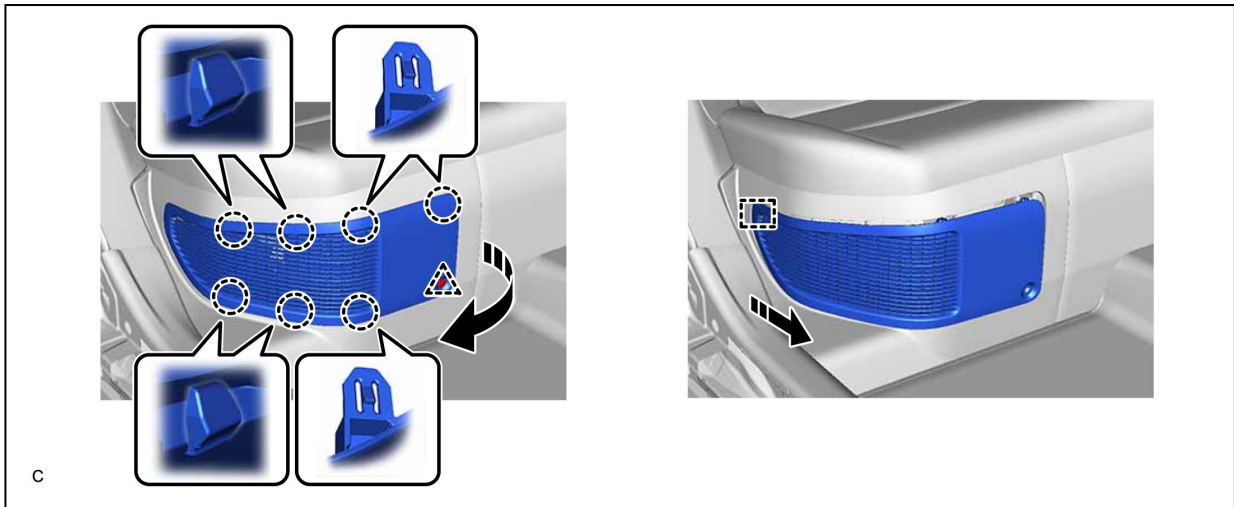

5. Remove service plug grip.

| | | |
|--|--|--|
| | <p>CAUTION:</p> <ul style="list-style-type: none">• Be sure to wear insulated gloves.• Do not inspect or service the high voltage system with the service plug grip installed.• To reduce the risk of electric shock, make sure to remove the service plug grip to cut off the high voltage circuit before servicing the vehicle. | |
|--|--|--|



- To reduce the risk of electric shock, make sure to wait at least 10 minutes after removing the service plug grip to fully discharge the high voltage capacitor inside the inverter with converter assembly.
- Keep the removed service plug grip in your pocket to prevent other technicians from accidentally installing it while you are servicing the vehicle.



NOTICE:

- After removing the service plug grip, turning the power switch on (READY) may cause a malfunction. Do not turn the power switch on (READY) unless instructed by the repair manual.
- Do not touch the terminals of the service plug grip.
- If the service plug grip has been struck or dropped, replace it.

HINT:

Waiting for at least 10 minutes is required to discharge the high voltage capacitor inside the inverter with converter assembly.

- (1) While wearing insulated gloves, rotate the handle of the service plug grip and remove the service plug grip as indicated by the arrows, in the order shown in the illustration.

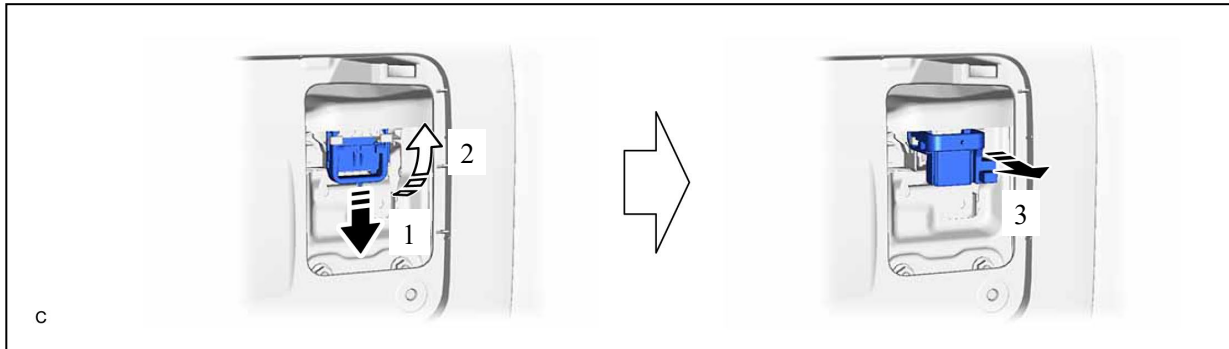

6. Make other staff aware that a high-voltage system is being dismantled by using the following sign: CAUTION: HIGH-VOLTAGE. DO NOT TOUCH (see page 23).

7. If the service plug grip cannot be removed due to damage to the vehicle, remove the **IGP-MAIN NO. 1** fuse.

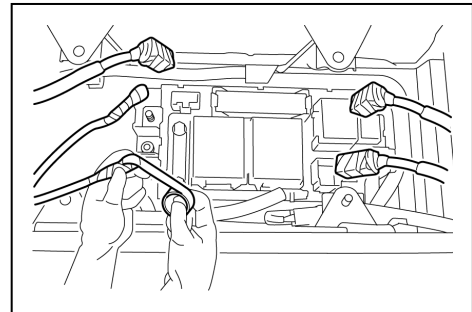

CAUTION:

This operation shuts off the HV system. Be sure to wear insulated gloves because high voltage is not shut off inside the HV battery. When it is possible to remove the service plug grip, remove it and continue the procedure.

8. After disconnecting or exposing a high-voltage connector or terminal, insulate it immediately using insulating tape. Before disconnecting or touching a bare high-voltage terminal, wear insulated gloves.

9. Check the HV battery and nearby area for leakage. If you find any liquid, it may be strong alkaline electrolyte. Wear rubber gloves and goggles and neutralize the liquid using a saturated boric acid solution or vinegar. Then wipe up the liquid using waste rags etc.
10. If the electrolyte comes into contact with your skin, wash the skin immediately using a saturated boric acid solution or a large amount of water. If the electrolyte adheres to any article of clothing, take the clothing off immediately.
11. If the electrolyte comes into contact with your eye(s), call out loudly for help. Do not rub your eye(s). Instead, wash the eye(s) with a dilute boric acid solution or a large amount of water and seek medical care.
12. With the exception of the HV battery, remove parts by following procedures which are similar to conventional Lexus vehicles. For the removal of the HV battery, refer to the following pages.

Person in charge: _____

CAUTION:
HIGH-VOLTAGE.
DO NOT TOUCH.

CAUTION:
HIGH-VOLTAGE.
DO NOT TOUCH.

Person in charge: _____

When performing work on the HV system, fold this sign and put it on the roof of the vehicle.

Removal of HV battery



WARNING:

- *Be sure to wear insulated gloves when handling high-voltage parts.*
- *Even if the vehicle is shut off and the relays are off, be sure to remove the service plug grip before performing any further work.*
- *Power remains in the high voltage electrical system for 10 minutes even after the HV battery assembly is shut off because the circuit has a condenser that stores power.*
- *Make sure that the tester reading is 0 V before touching any high-voltage terminals which are not insulated.*
- *The SRS may remain powered for up to 90 seconds after the vehicle is shut off or disabled. To prevent serious injury or death from unintentional SRS deployment, avoid cutting the SRS components.*

1. SHUT OFF IGNITION (**READY** indicator is off)
2. REMOVE BATTERY SERVICE COVER PLATE

a.

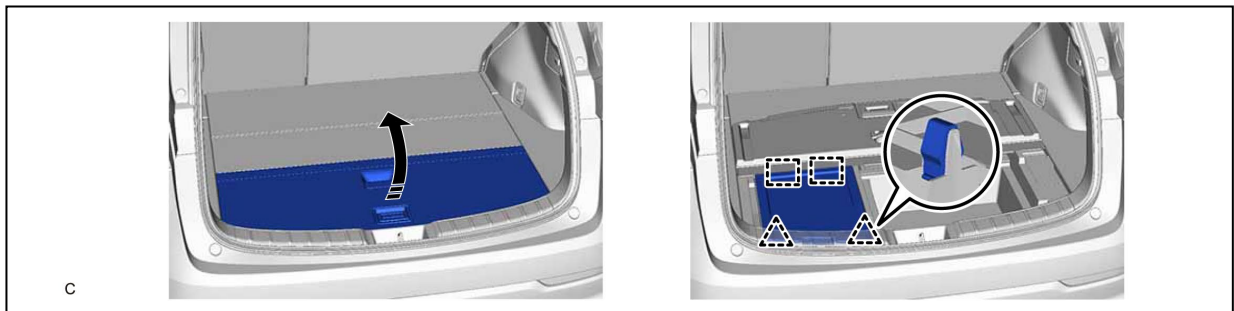

3. DISCONNECT CABLE FROM NEGATIVE AUXILIARY BATTERY TERMINAL

a.

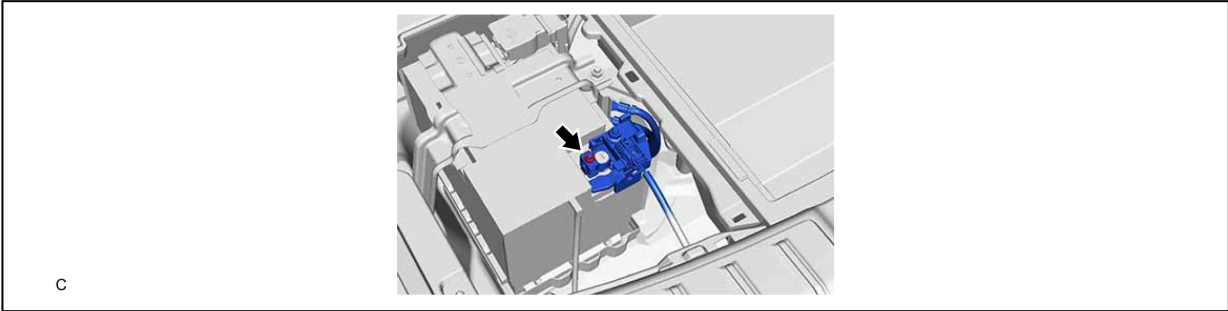

4. REMOVE BATTERY SERVICE HOLE COVER

a.

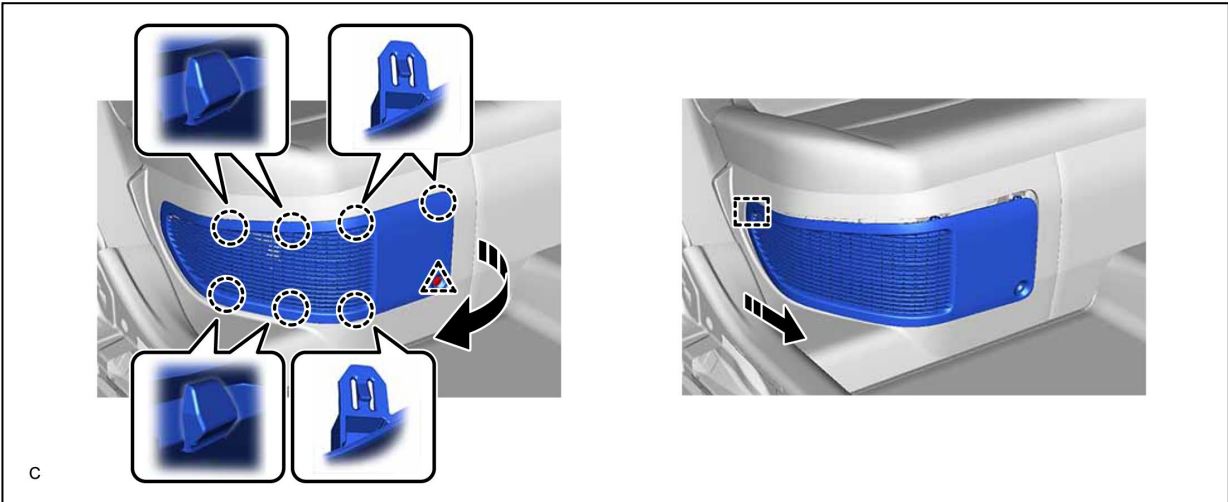

| | | | |
|--|--------------------------|---|---|
| | Remove in this Direction | — | — |
|--|--------------------------|---|---|

5. REMOVE SERVICE PLUG GRIP

CAUTION:

- Be sure to wear insulated gloves.
- Do not inspect or service the high voltage system with the service plug grip installed.
- To reduce the risk of electric shock, make sure to remove the service plug grip to cut off the high voltage circuit before servicing the vehicle.

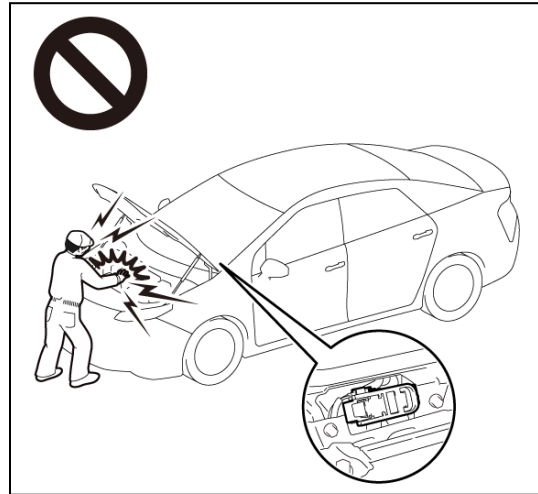

- To reduce the risk of electric shock, make sure to wait at least 10 minutes after removing the service plug grip to fully discharge the high voltage capacitor inside the inverter with converter assembly.
- Keep the removed service plug grip in your pocket to prevent other technicians from accidentally installing it while you are servicing the vehicle.

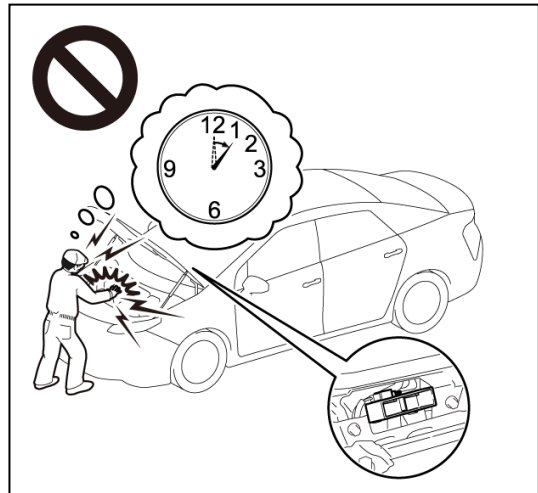



NOTICE:

- After removing the service plug grip, turning the power switch on (READY) may cause a malfunction. Do not turn the power switch on (READY) unless instructed by the repair manual.
- Do not touch the terminals of the service plug grip.
- If the service plug grip has been struck or dropped, replace it.

HINT:

Waiting for at least 10 minutes is required to discharge the high voltage capacitor inside the inverter with converter assembly.

a.

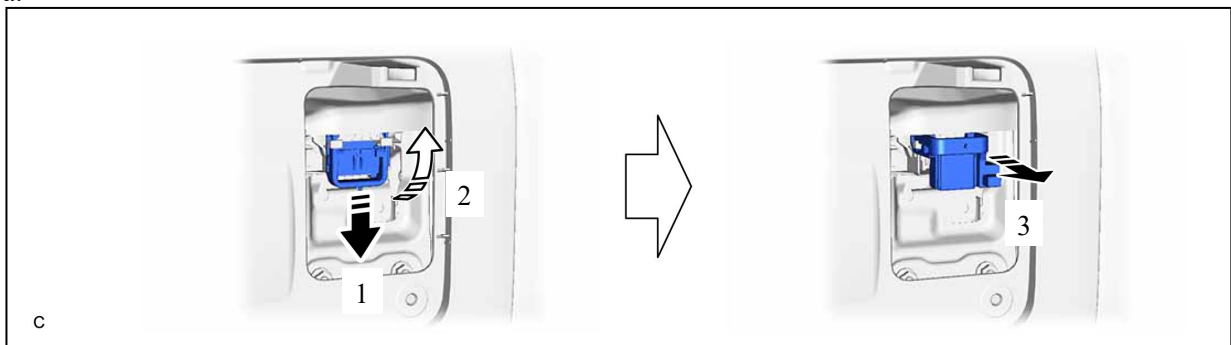

c

- (1) While wearing insulated gloves, rotate the handle of the service plug grip and remove the service plug grip as indicated by the arrows, in the order shown in the illustration.

6. REMOVE NO. 2 INVERTER PROTECTOR

a.

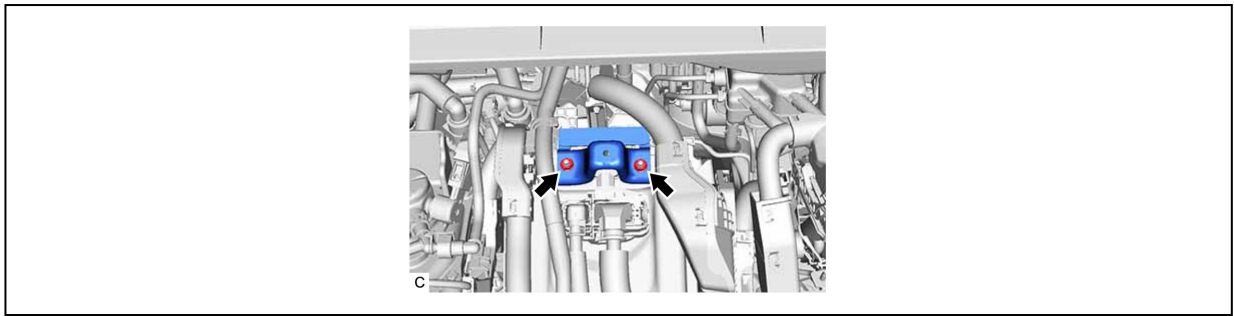

7. DISCONNECT ENGINE ROOM MAIN WIRE

| | |
|---|---|
|  | CAUTION: |
| | Be sure to wear insulated gloves. NOTICE: Do not allow any foreign matter or water to enter the hybrid motor control inverter assembly. |

a.

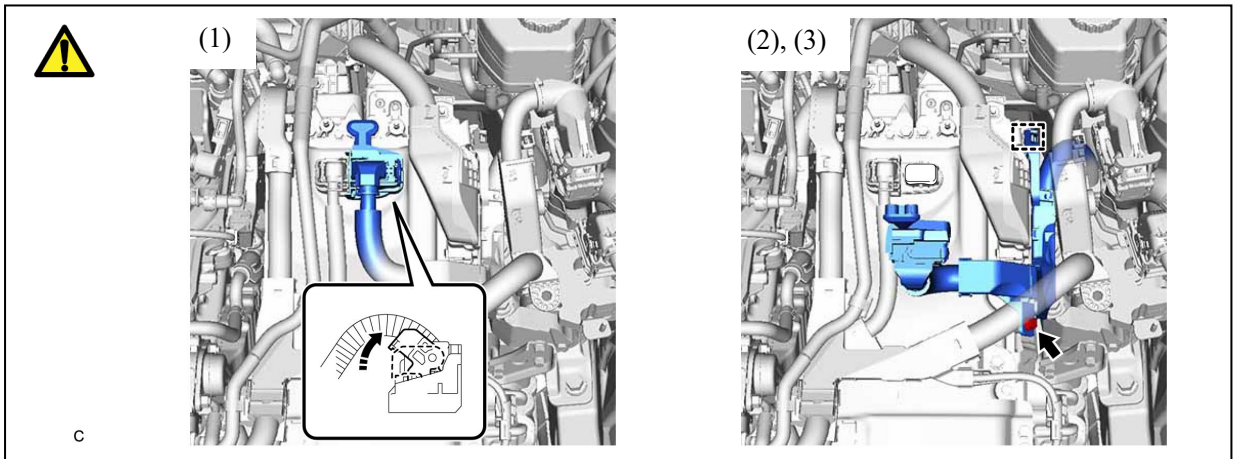

- (1) Move the lock lever as shown in the illustration and disconnect the inverter with converter assembly connector.

NOTICE:

- Do not touch the waterproof seal or terminals of the connector.
- Do not damage the terminals, connector housing or inverter with converter assembly during disconnection.
- Cover the hole where the cable was connected with tape (non-residue type) or equivalent to prevent entry of foreign matter.
- Insulate the disconnected terminals with insulating tape.

- (2) Remove the bolt.
- (3) Disengage the clamp and disconnect the engine room main wire.

8. REMOVE CONNECTOR COVER ASSEMBLY

| | |
|---|---|
|  | <p>CAUTION: Be sure to wear insulated gloves.</p> |
|---|---|

a.

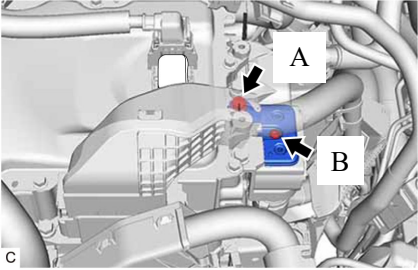
| | | |
|---|-----------------|---|
|  | <p>(1), (2)</p> |  |
|---|-----------------|---|

- (1) Remove the bolt (A).
- (2) Using a T25 "TORX" socket wrench, remove the bolt (B) and connector cover assembly from the inverter with converter assembly.

NOTICE:

- Do not touch the connector cover assembly waterproof seal.
- Do not allow any foreign matter or water to enter the inverter with converter assembly.

9. CHECK TERMINAL VOLTAGE



CAUTION:
Be sure to wear insulated gloves.

a.



(1)

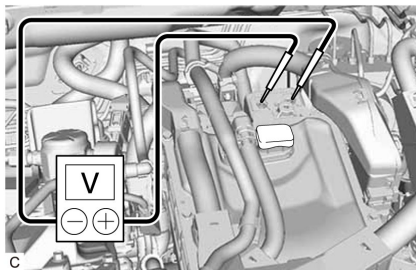

(1) Using a voltmeter, measure the voltage between the terminals of the 2 phase connectors.

Standard Voltage:

0 V

NOTICE:

Do not allow any foreign matter or water to enter the inverter with converter assembly.

HINT:

Use a measuring range of DC 750 V or more on the voltmeter.

10. REMOVE REAR SEAT CUSHION ASSEMBLY

a.

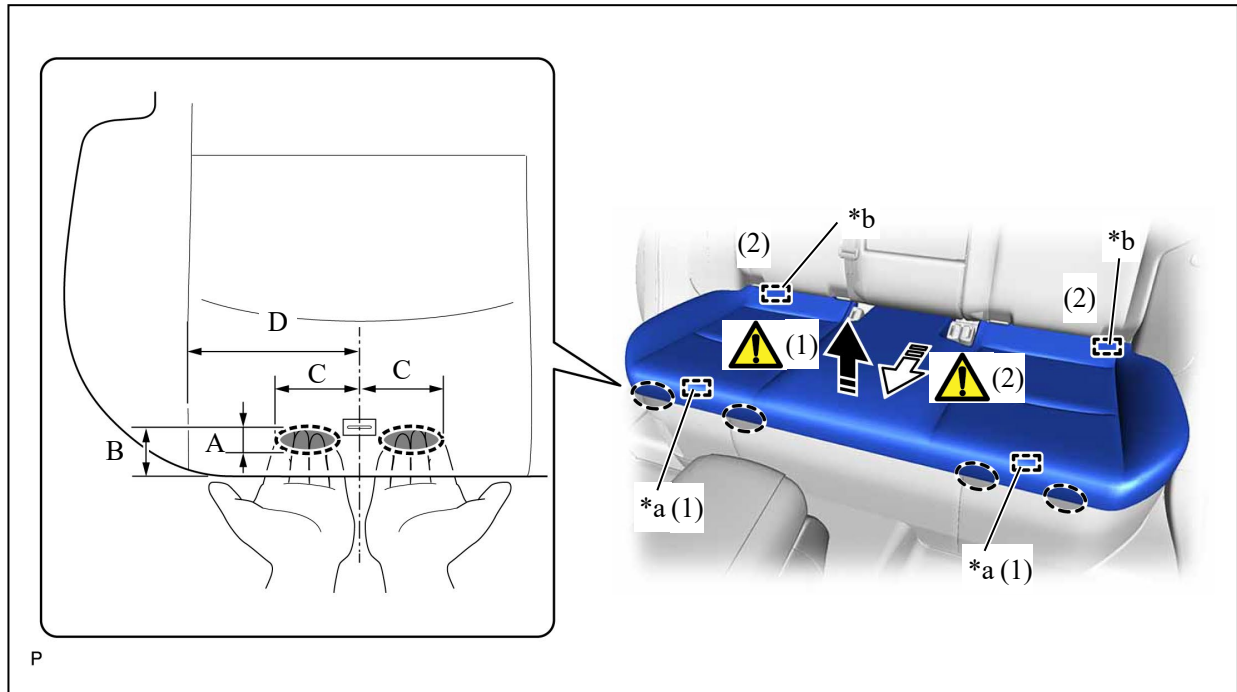

| | | | |
|----|---|----|--|
| *a | Rear Seat Cushion Frame Hook (Front Side) | *b | Rear Seat Cushion Frame Hook (Rear Side) |
| | Place Hand Here | | Remove in this Direction (1) |
| | Remove in this Direction (2) | — | — |

- (1) Lift the front edge of the rear seat cushion assembly as shown in the illustration and disengage the 2 rear seat cushion frame hooks on the front side of the rear seat cushion assembly from the rear seat cushion lock hooks.

Standard Measurement:

| Area | Measurement | Area | Measurement |
|------|------------------|------|-------------------|
| A | 30 mm (1.18 in.) | B | 60 mm (2.36 in.) |
| C | 80 mm (3.15 in.) | D | 150 mm (5.91 in.) |

NOTICE:

- Disengage each hook at the front part of the rear seat cushion frame one area at a time.
- Be sure to hold the parts of the seat cushion assembly directly next to the rear seat cushion frame hooks when lifting it. Lifting a different part of the cushion may deform the rear seat cushion frame.

(2) Disengage the 2 rear seat cushion frame hooks on the rear side of the rear seat cushion assembly as shown in the illustration.

NOTICE:



Be careful not to damage the vehicle body.

- (3) Disconnect each connector.
- (4) Remove the rear seat cushion assembly.

11. REMOVE REAR DOOR SCUFF PLATE LH

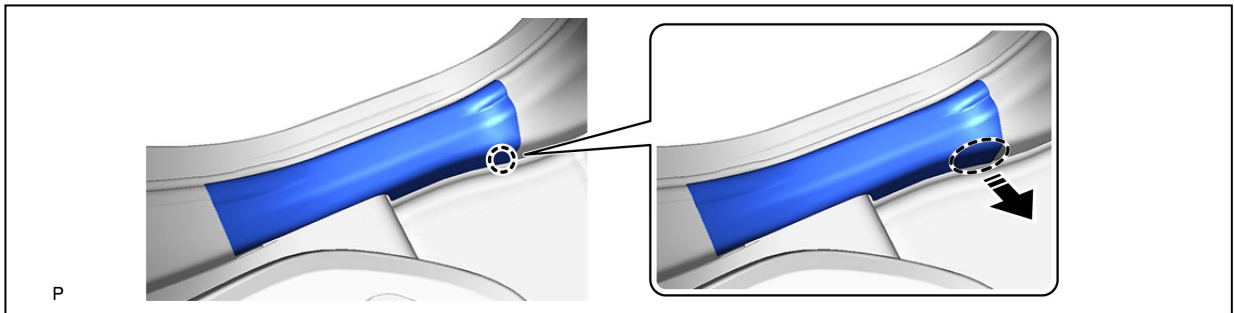
(1)



| | | | |
|---|-----------------|---|--------------------------|
|  | Place Hand Here |  | Remove in this Direction |
|---|-----------------|---|--------------------------|

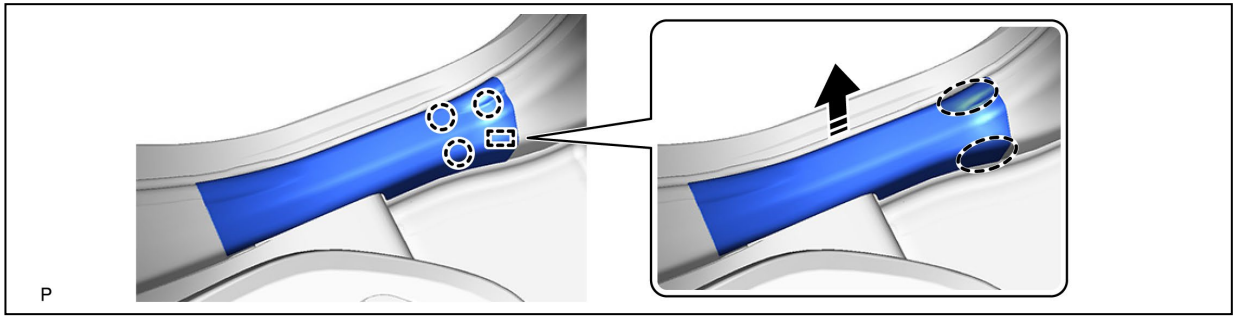

(2)

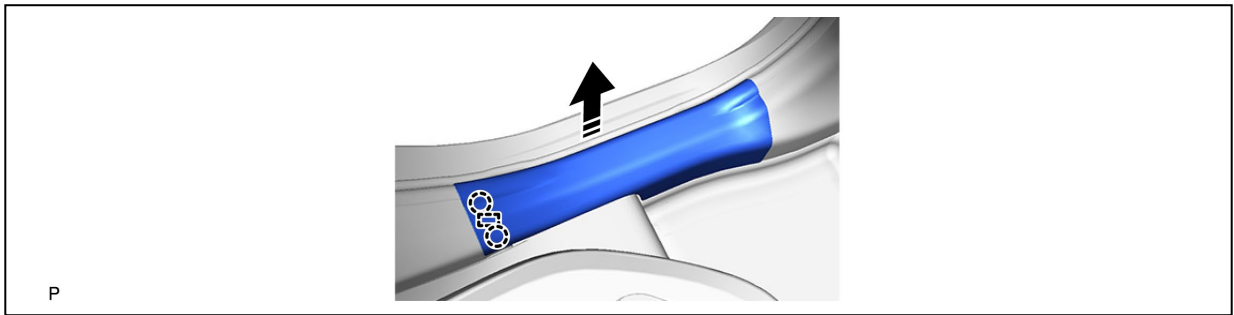

| | | | |
|---|-----------------|---|--------------------------|
|  | Place Hand Here |  | Remove in this Direction |
|---|-----------------|---|--------------------------|

(3)



| | | | |
|---|-----------------|---|--------------------------|
|  | Place Hand Here |  | Remove in this Direction |
|---|-----------------|---|--------------------------|

12. REMOVE NO. 3 BATTERY SERVICE COVER BOARD

a.

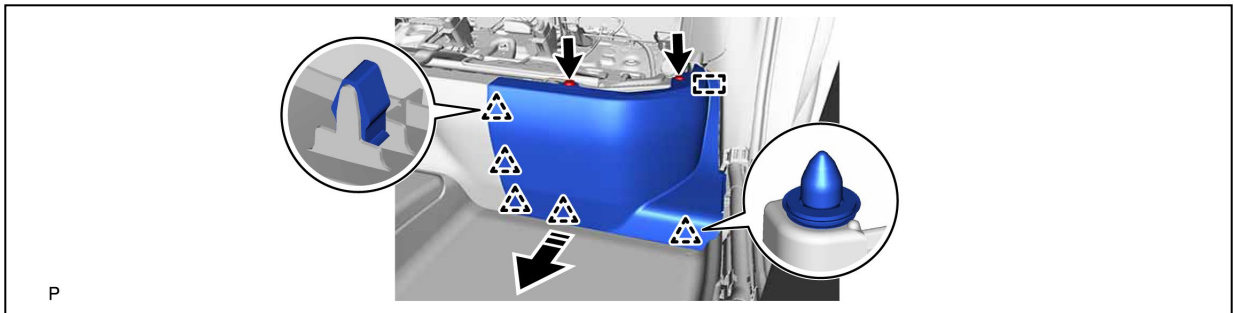

| | | | |
|---|--------------------------|---|---|
|  | Remove in this Direction | — | — |
|---|--------------------------|---|---|

13. REMOVE REAR DOOR SCUFF PLATE RH

(1) Use the same procedure as for the LH side.

14. REMOVE NO. 2 BATTERY SERVICE COVER BOARD

(1) Use the same procedure as for the LH side.

15. REMOVE NO. 1 BATTERY SERVICE COVER BOARD

a.

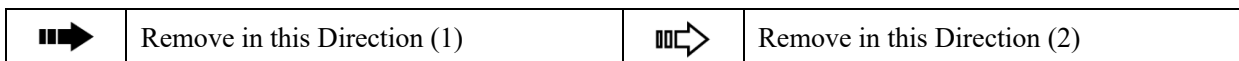
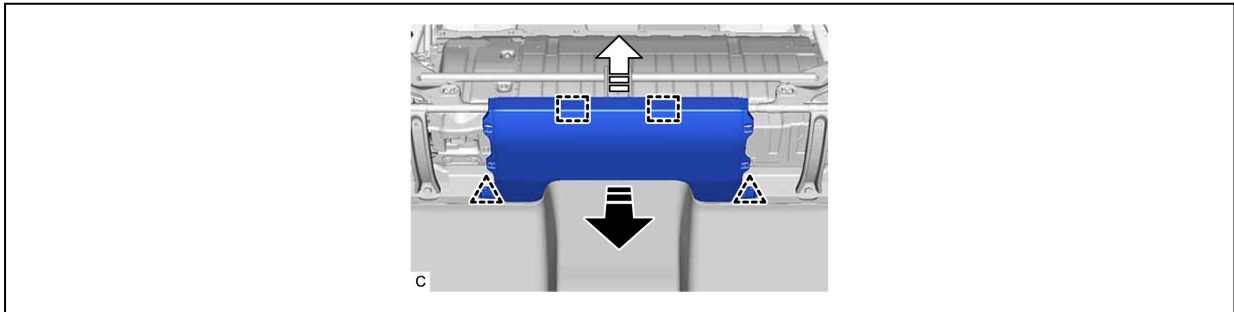

16. REMOVE REAR SEAT CUSHION LEG SUB-ASSEMBLY

a.

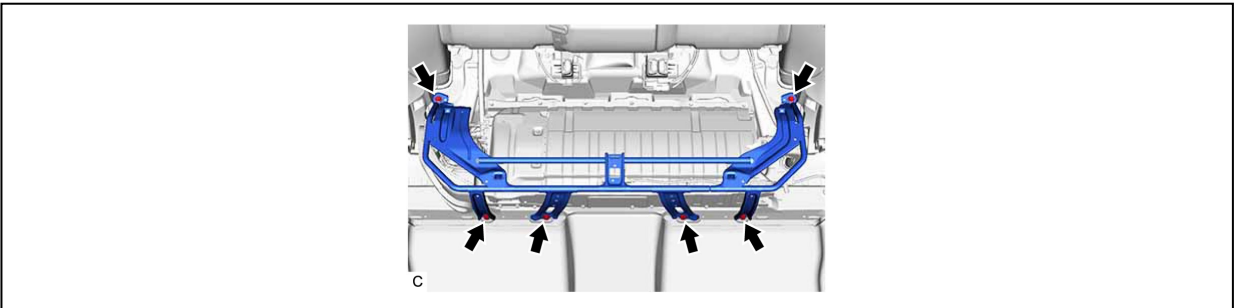

17. REMOVE NO. 1 HYBRID BATTERY INTAKE DUCT

a.

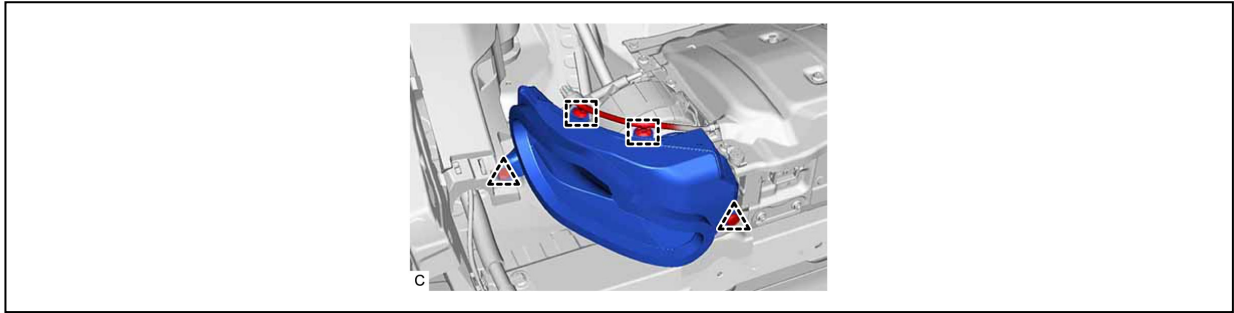

18. REMOVE BATTERY COOLING BLOWER ASSEMBLY

a.

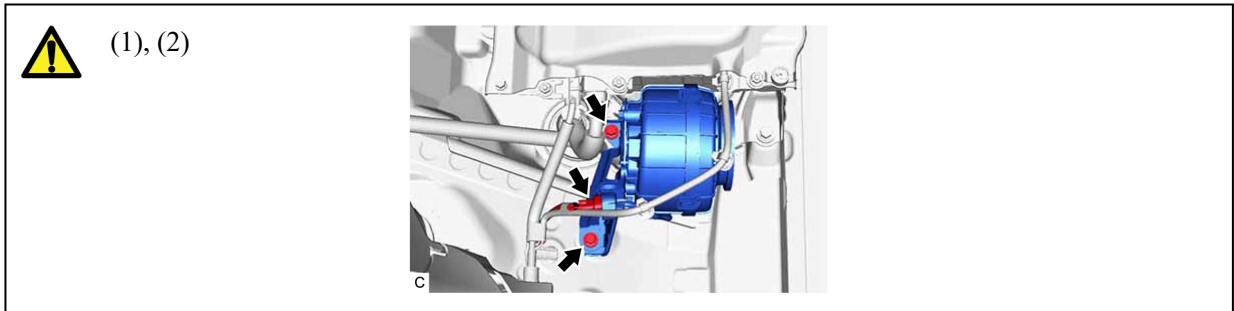

- (1) Disconnect the battery cooling blower assembly connector.
- (2) Remove the 2 bolts and battery cooling blower assembly from the HV battery.

NOTICE:

- Be sure not to touch the fan part of the battery cooling blower assembly.
- Do not lift the battery cooling blower assembly using the wire harness.

19. REMOVE NO. 1 HV BATTERY COVER PANEL RH

| | |
|---|---|
|  | <p>CAUTION: Be sure to wear insulated gloves.</p> |
|---|---|

a.

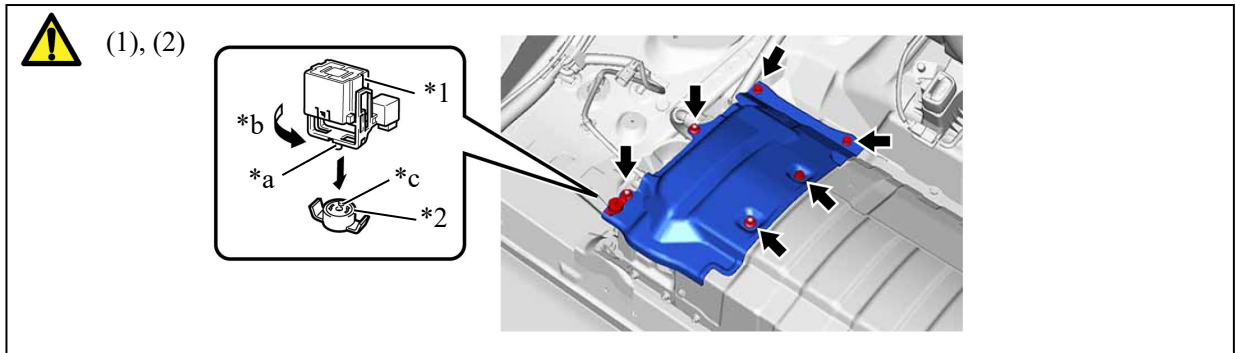

| | | | |
|----|-------------------|----|----------------------------|
| *1 | Service Plug Grip | *2 | Battery Cover Lock Striker |
| *a | Projection | *b | Turn |
| *c | Button | — | — |

(1) Using the service plug grip, remove the battery cover lock striker.

HINT:

Insert the projection of the service plug grip and turn the button of the battery cover lock striker counterclockwise to release the lock.

(2) Remove the 3 bolts, 3 nuts and No. 1 HV battery cover panel RH from the HV battery.

20. DISCONNECT HV FLOOR UNDER WIRE

| | |
|---|--|
|  | <p>CAUTION: Be sure to wear insulated gloves.</p> |
|---|--|

a.

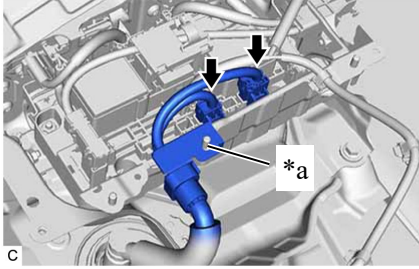
| | | |
|---|-----------------|--|
|  | <p>(1), (2)</p> |  |
|---|-----------------|--|

| | | | |
|----|---------------|---|---|
| *a | Shield Ground | - | - |
|----|---------------|---|---|

(1) Disconnect the 2 HV battery junction block assembly connectors.

NOTICE:

Insulate each disconnected high-voltage connector with insulating tape. Wrap the connector from the wire harness side to the end of the connector.

(2) Disconnect the shield ground from the HV battery.

21. DISCONNECT FLOOR WIRE

| | |
|---|--|
|  | <p>CAUTION: Be sure to wear insulated gloves.</p> |
|---|--|

a.

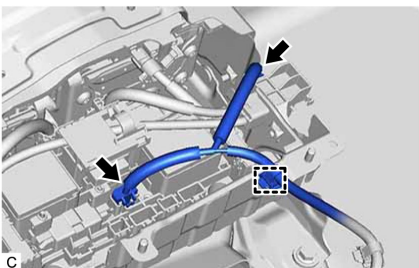
| |
|--|
|  |
|--|

22. REMOVE HYBRID BATTERY HOSE ASSEMBLY

a.

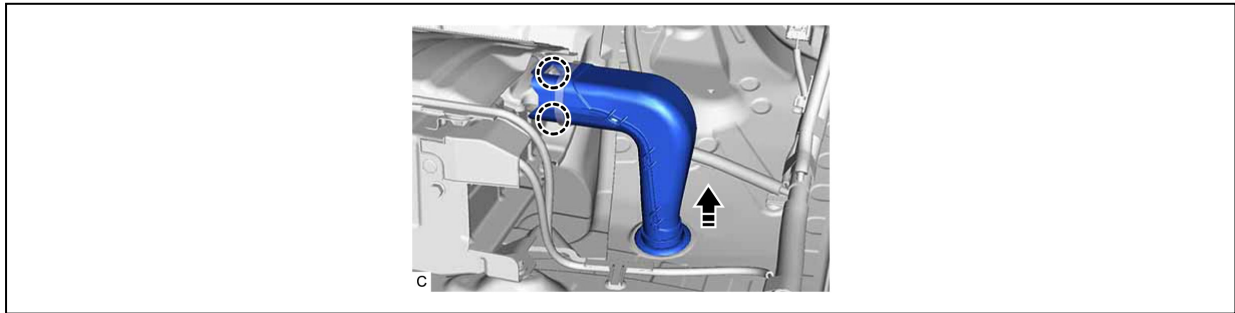

23. REMOVE NO. 2 INDOOR ELECTRICAL KEY ANTENNA ASSEMBLY

a.

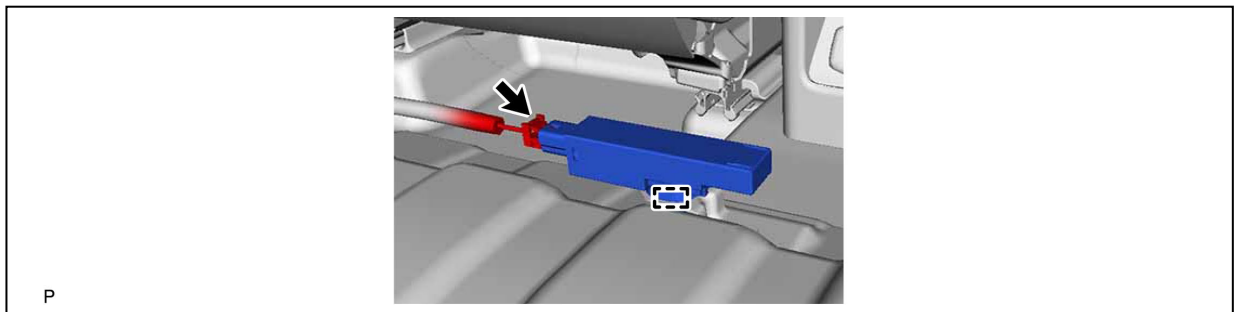

24. DISCONNECT FLOOR WIRE



CAUTION:
Be sure to wear insulated gloves.

a.

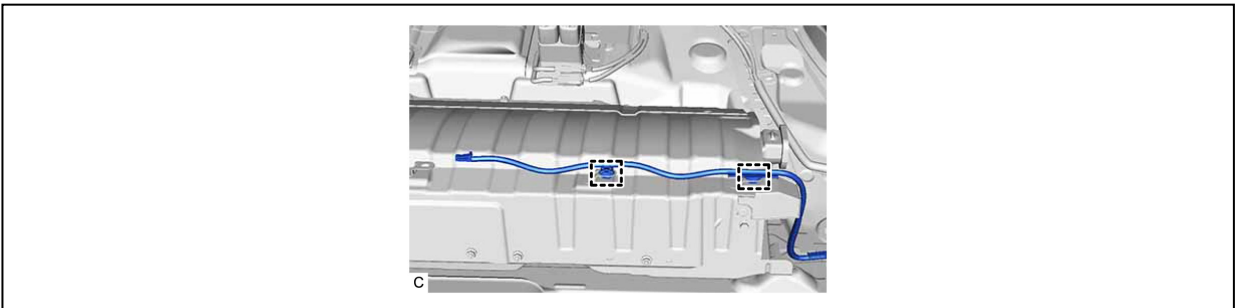

25. REMOVE NO. 4 HV BATTERY PROTECTOR

| | |
|---|---|
|  | <p>CAUTION: Be sure to wear insulated gloves.</p> |
|---|---|

a.

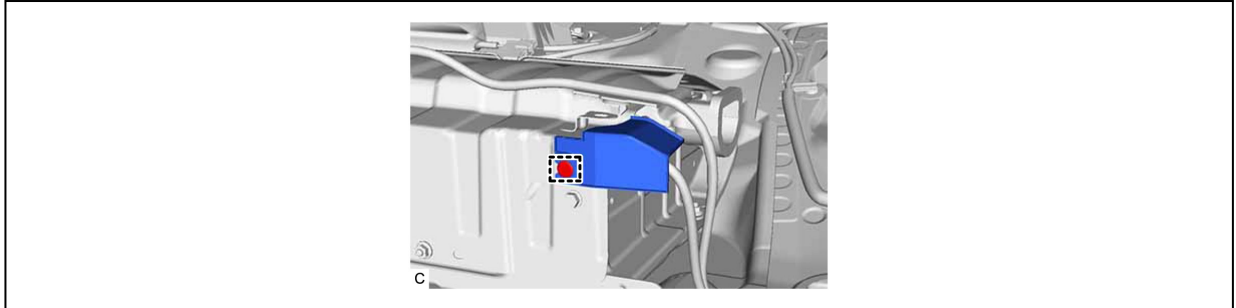

26. DISCONNECT FLOOR WIRE

| | |
|---|---|
|  | <p>CAUTION: Be sure to wear insulated gloves.</p> |
|---|---|

a.

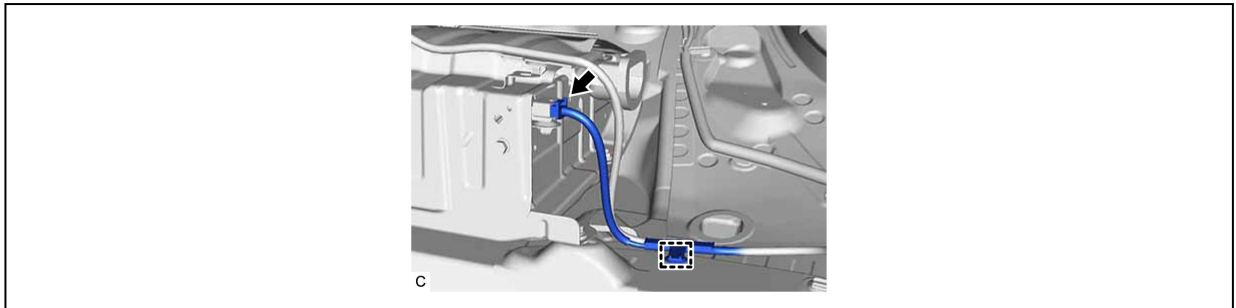

27. REMOVE HV BATTERY

CAUTION:

Be sure to wear insulated gloves.

NOTICE:

- Do not allow foreign matter, such as grease or oil, to adhere to the bolts of the HV battery.
- To prevent the wire harness from being caught, make sure to bundle the wire harness using insulating tape or equivalent.
- Use cardboard or another similar material to protect the HV battery and vehicle body from damage.
- Since the HV battery is very heavy, 2 people are needed to remove it. When removing the HV battery, be careful not to damage the parts around it.
- When removing the HV battery from the vehicle, do not allow it to contact the vehicle.
- When removing/installing/moving the HV battery, make sure not to tilt it more than 80°.
- Insulate the disconnected terminals or connectors with insulating tape.



a.

